

CuffMend™ Rotator Cuff Augmentation System

Surgical Technique

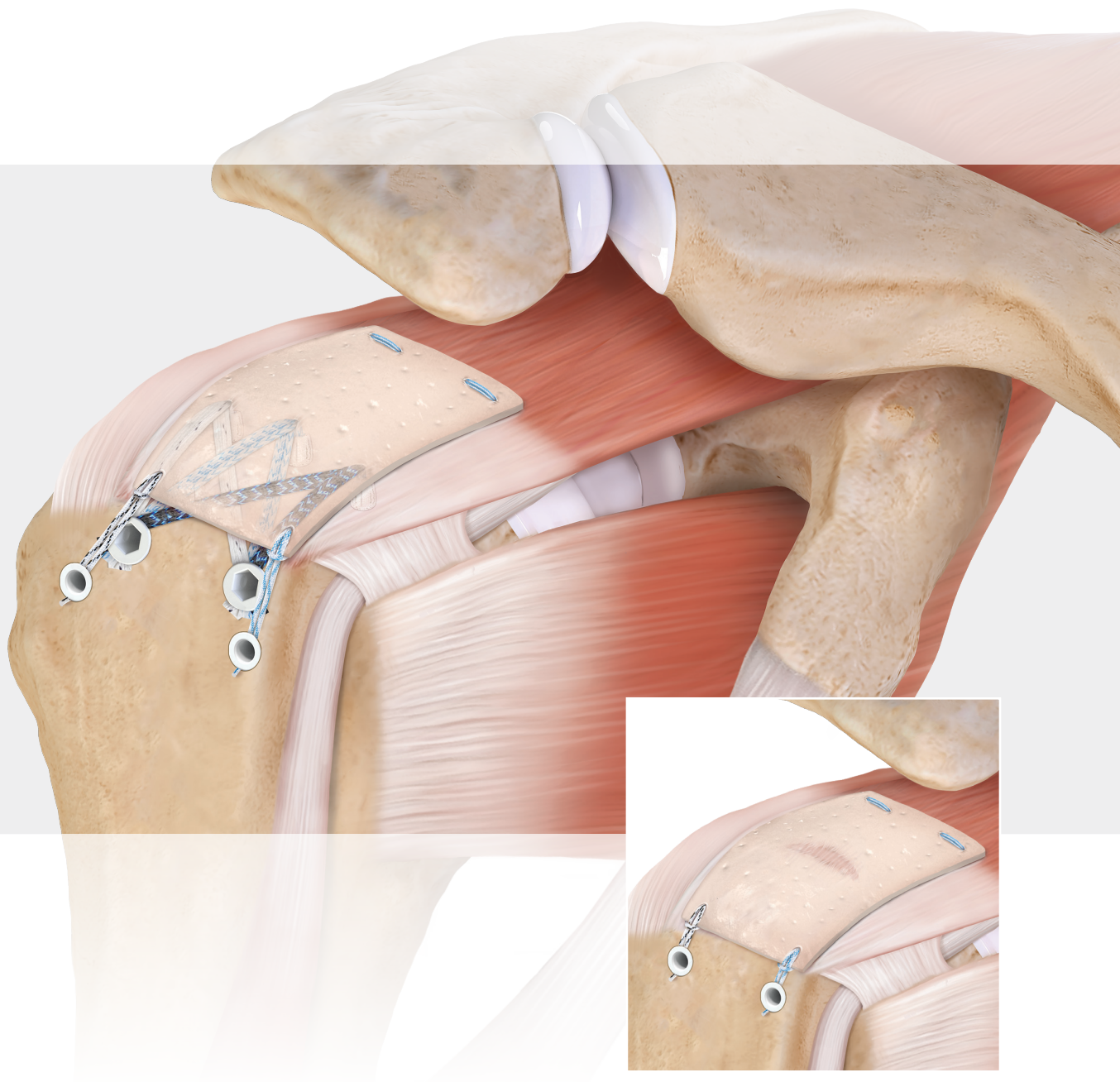

CuffMend™ Rotator Cuff Augmentation System

Providing an efficient, simple approach to augmenting partial-and full-thickness rotator cuff tears, the CuffMend system incorporates ArthroFlex dermal allograft for supplemental strength and to support healing.^{1,2} Insert the graft using the graft spreader and then securely fixate the graft using FiberStitch™ implant 1.5, curved or straight (RC) with two polyester implants and 2-0 FiberWire® suture for medial soft-tissue fixation and Knotless PushLock® anchors for lateral bony fixation. Scientific literature has demonstrated that rotator cuff augmentation with acellular dermal matrix can be effective.²⁻⁴

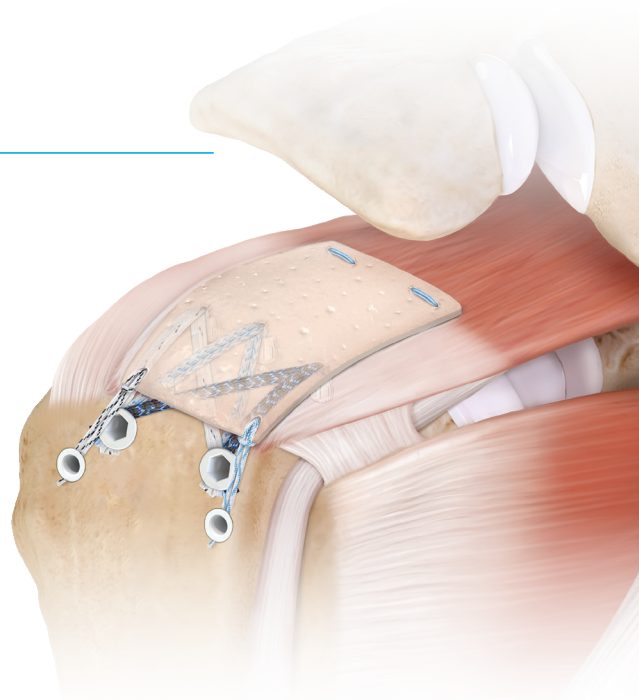

ArthroFLEX® Dermal Allograft

ArthroFlex dermal allograft is a biohospitable acellular dermal allograft intended for supplemental support and covering for soft-tissue repair.^{2,5}

LifeNet Health's patented and validated Matrancell® decellularization process renders the ArthroFlex dermal allograft acellular without compromising its biomechanical or biochemical properties. Matrancell technology removes donor DNA from the dermal matrix, ensuring a biocompatible scaffold that retains its growth factors, native collagen scaffold, and elastin. Matrancell technology is validated to remove ≥97% of donor DNA and cellular content, far less than other commercially available acellular dermal matrices.⁵

ArthroFlex is treated with Preservon®, a proprietary and patented preservation technology that allows the graft to be fully hydrated at room temperature while avoiding the water-mediated lysis of the natural collagen and elastin scaffold.⁵

- Augmentation with ArthroFlex dermal allograft has demonstrated improved clinical outcomes^{3,4}
- ArthroFlex dermal allograft provides supplemental strength to the repair and protects the repair to allow healing²
- Augmentation with ArthroFlex dermal allograft can reduce retear rates³
- Biomechanical testing has shown that ArthroFlex dermal allograft provides high ultimate load and suture retention strength⁶
- ArthroFlex dermal allograft has demonstrated the ability to remodel and integrate with host tissue after implantation¹
- ArthroFlex is available in various pre-cut sizes for use in augmentation



≥97% DNA and Cellular Content Removed	Removing cells and immunogenic components allow host cells to readily infiltrate and proliferate ⁵
Intact Acellular Extracellular Matrix	Provides a strong, biohospitable collagen scaffold for host cellular and vascular ingrowth ⁵
Convenience	Excellent handling; ready to use; room temperature storage (15°C-30°C) ⁷
Supports Rapid Healing	Retains growth factors, elastin, matrikines, cytokines, and collagens ⁸

Autograft Tissue Compression System

- The Autograft Tissue Compression System is designed to create a graft using autologous tissue, such as biceps tendon. The graft can be used for CuffMend rotator cuff augmentation.
- The Autograft Tissue Compression System consists of a press and disposable plates. Holes in the plates can be used to help suture the graft.
- For details on preparing the graft, please see pages 24-28.

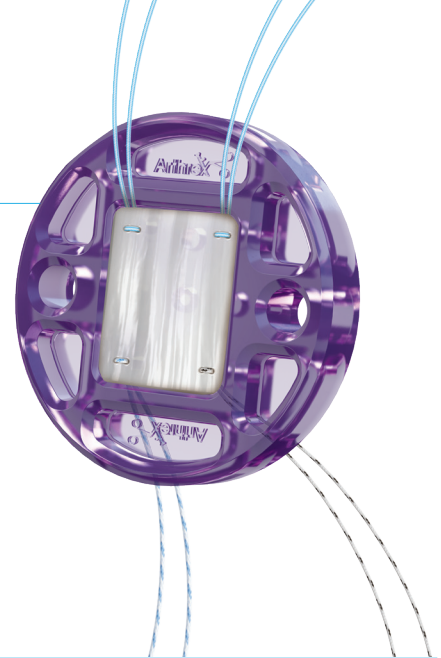

FiberStitch™ Implant 1.5, Curved or Straight (RC) With Two Polyester Implants and 2-0 FiberWire® Sutures

FiberStitch implant 1.5, curved or straight (RC) with two polyester implants and 2-0 FiberWire sutures provide a suture-based solution to quickly and securely attach the medial edge of the graft to the rotator cuff tendon.

- Delivery device uses single-handed operation to deliver two soft suture implants
- Implant features two polyester suture implants connected with a continuous 2-0 FiberWire suture
- Implants can be delivered through varying graft thicknesses, including 1 mm, 2 mm, or 3 mm ArthroFlex dermal allografts
- 1.5 mm needle easily penetrates through the graft and delivers a low-profile implant
- Integrated depth stop at 12 mm



CuffMend™ Graft Spreader

The CuffMend graft spreader provides a straightforward approach to introducing a graft and positioning it over the repair site for final fixation.

- Low-profile design to simplify inserting the graft into the subacromial space
- Articulating arm effortlessly positions the graft over the repair site
- Versatile design for insertion through the lateral, or posterior portals

3.5 mm Self-Punching PushLock® Suture Anchor

The self-punching PushLock suture anchor provides efficient tensioning and knotless fixation of the graft construct.

- Simplified and familiar insertion technique
- PEEK self-punching eyelet simplifies insertion
- Visualize and adjust suture tension prior to anchor insertion to prevent over-tensioning of the graft construct



Lateral Approach for CuffMend™ Rotator Cuff Augmentation

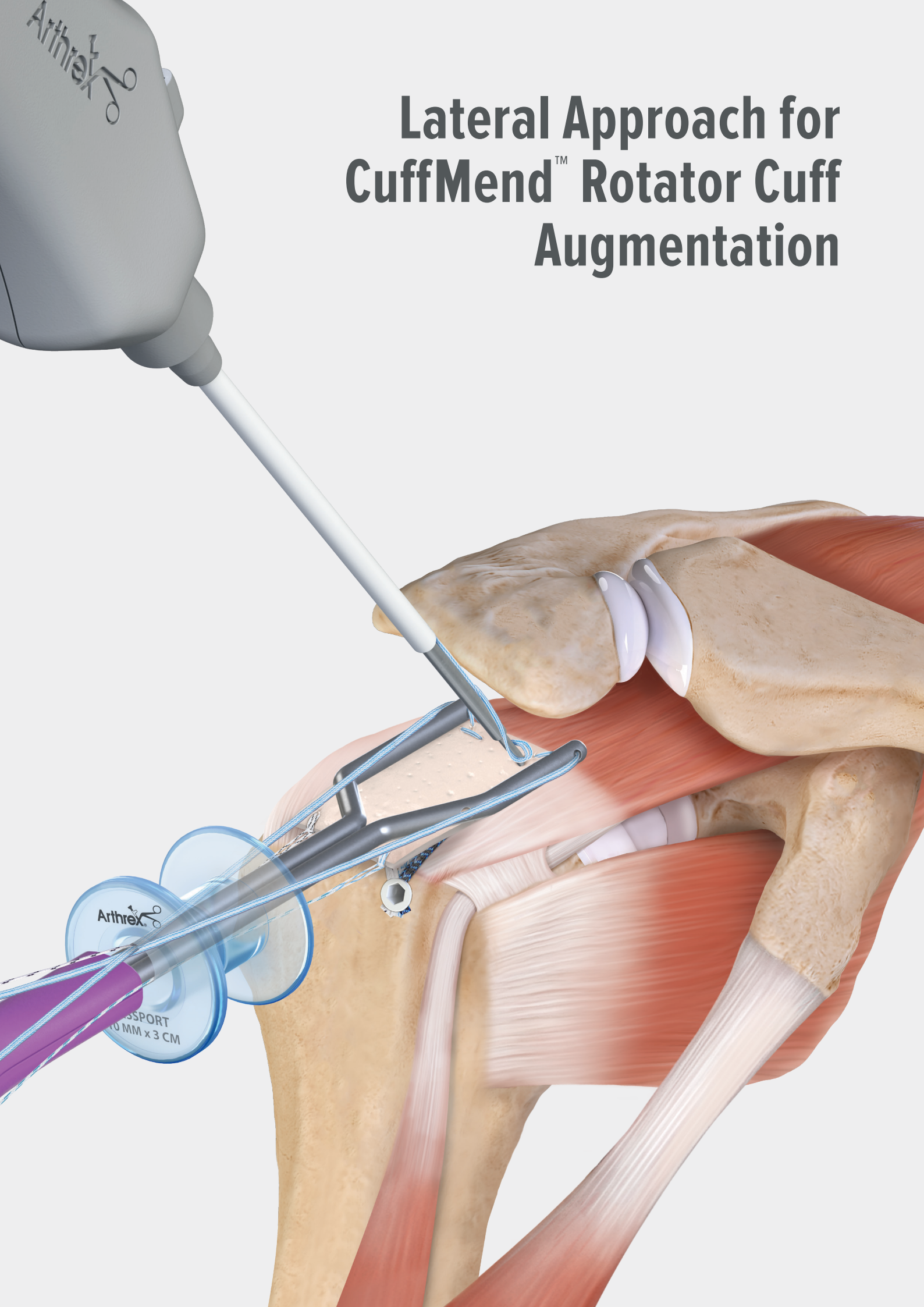

Portal Placement

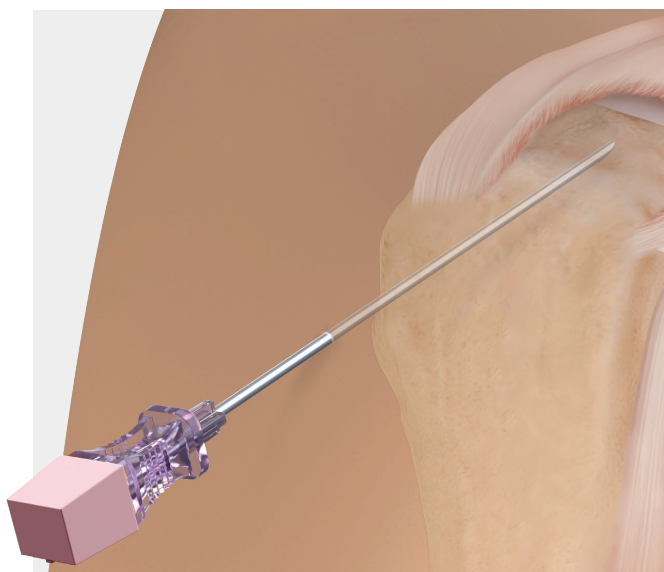

Lateral Portal

Use a spinal needle to create a lateral working portal for placement of a 10 mm PassPort Button™ cannula. It is very important to make the portal as parallel as possible to the surface of the rotator cuff, resulting in a lateral portal location that will be more inferior compared to a standard lateral working portal.



Optional Inferior Anterolateral Portal

An auxiliary inferior anterolateral portal may also be created to introduce the graft spreader into the subacromial space.

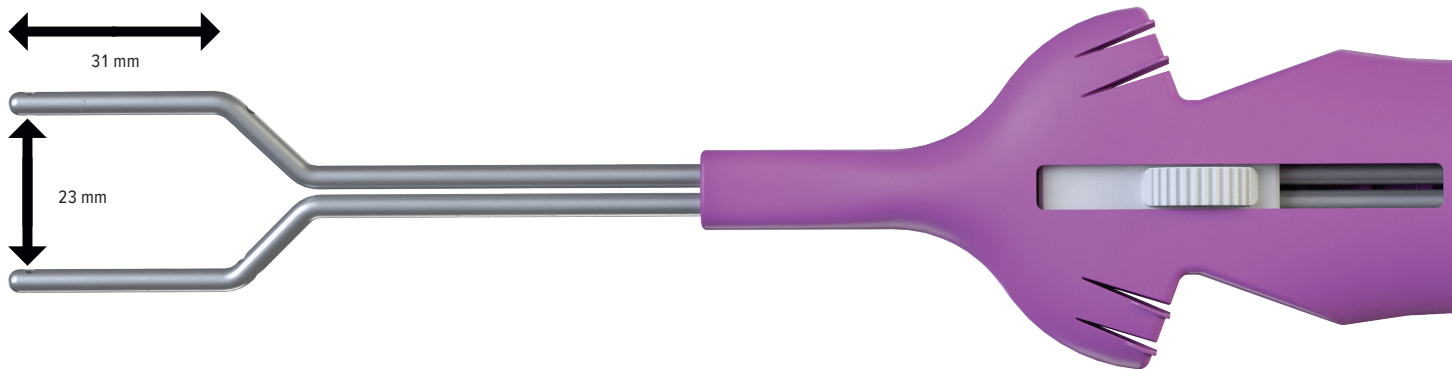

Graft Sizing

Insert the graft spreader into the subacromial space, and roll the wheel back to deploy. The arm of the graft spreader from the tip to the first bend is approximately 31 mm. Use this measurement as a reference for choosing the appropriately sized ArthroFlex precut graft.

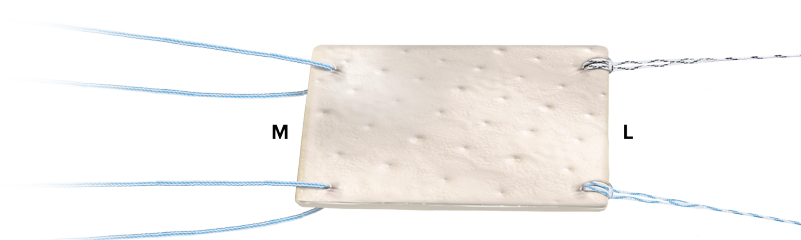

Graft Preparation for Lateral Approach with ArthroFLEX® Human Dermal Allograft

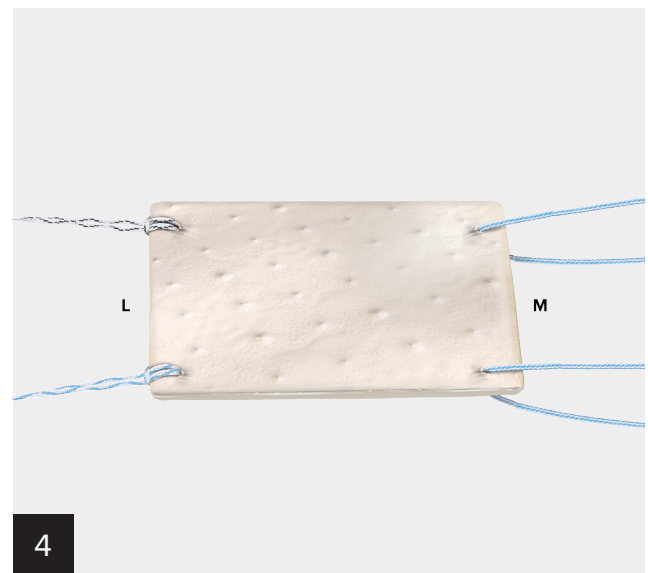
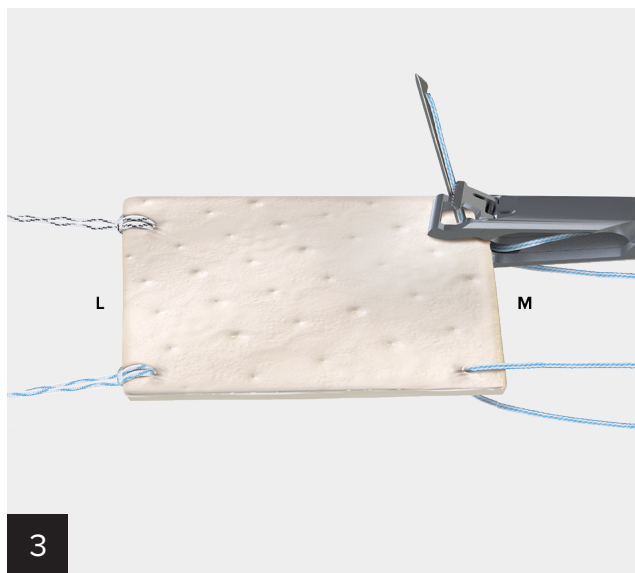
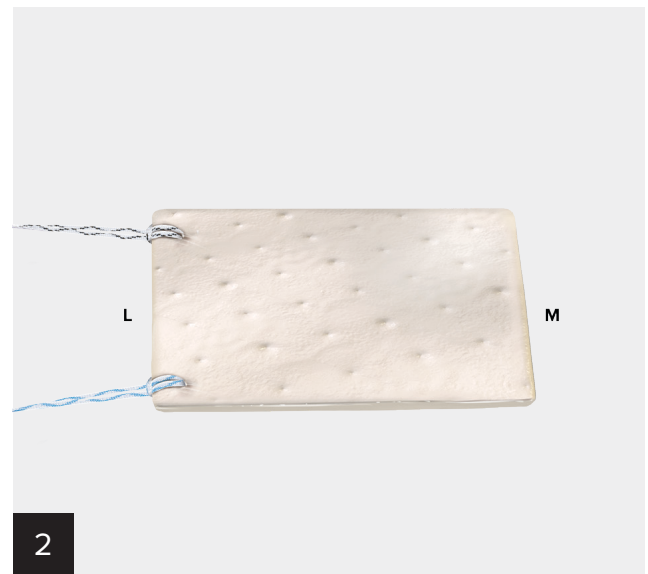
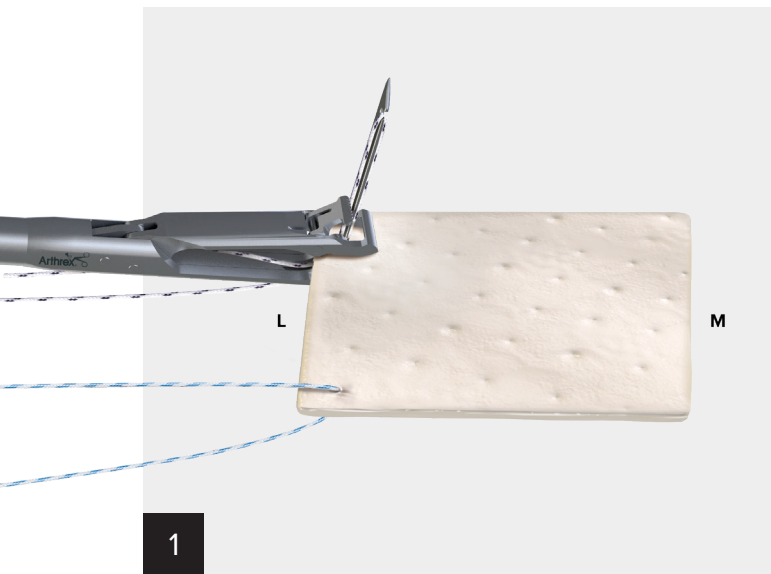

Using a Scorpion™ SL suture passer, place a 0.9 TigerLink™ SutureTape and a 0.9 FiberLink™ SutureTape into the lateral corners (L) of the ArthroFlex dermal allograft in a cinch stitch configuration. Prepare the medial corners (M) of the graft by passing a #0 FiberWire® suture in a simple pass configuration.

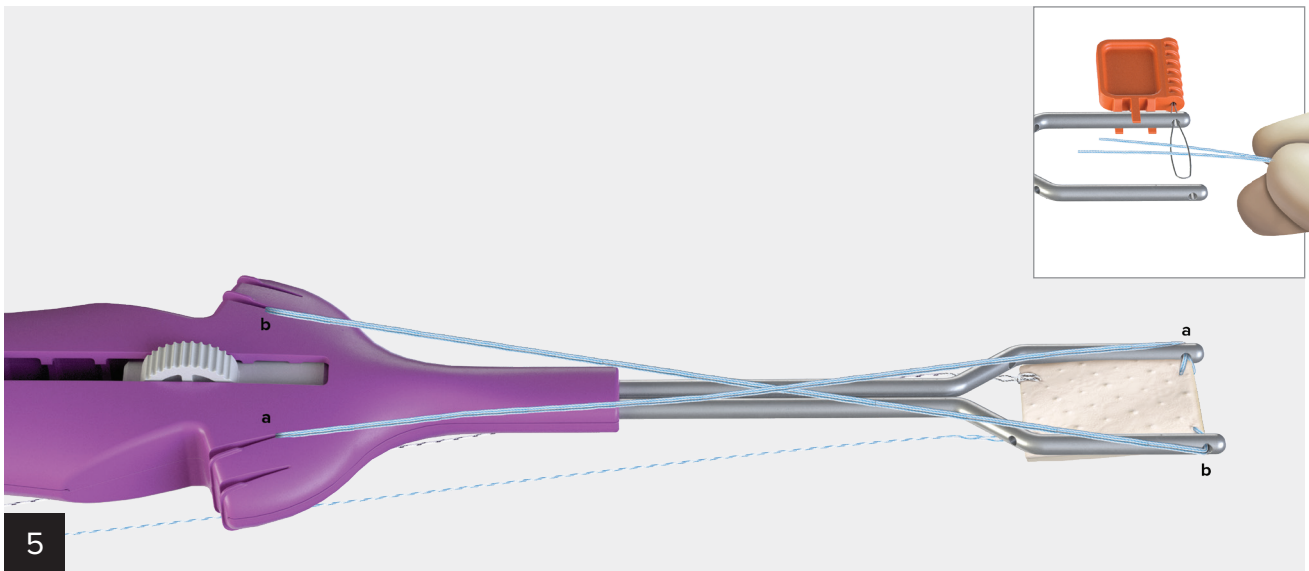

Using the orange suture passing flag, pass the #0 FiberWire® sutures from the medial aspect of the ArthroFlex graft into the suture channels at the distal end of the graft spreader (a, b). Take care to cleat the medial sutures on the inside cleats on the opposite side of the spreader arm it was passed through. This creates a crisscross pattern that eases passage through the 10 mm PassPort Button™ cannula and retains tension on the graft.

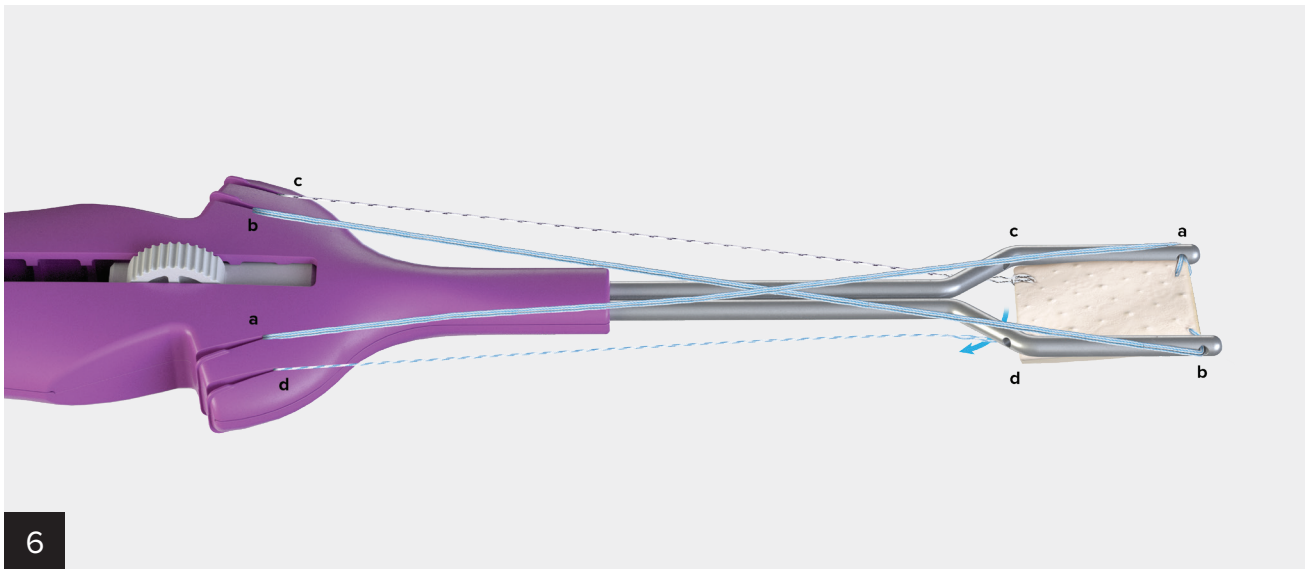

Pass the lateral TigerLink™ SutureTape and FiberLink™ SutureTape under the arms of the spreader and attach to the outside cleats (c,d) on the corresponding side of the graft spreader handle.

Note: Do not pass the lateral link sutures through the lateral holes on the graft spreader arms as this will complicate removal after graft insertion.

Graft Delivery

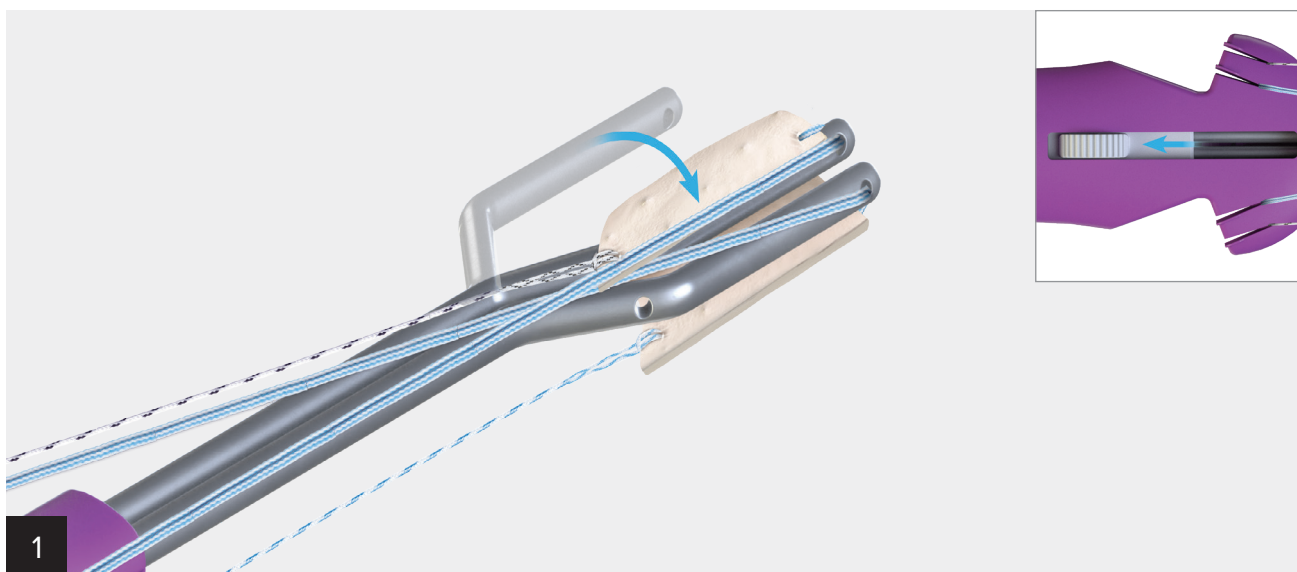

Once the graft is loaded onto the graft spreader, retract the articulating arm by sliding the button toward the handle.

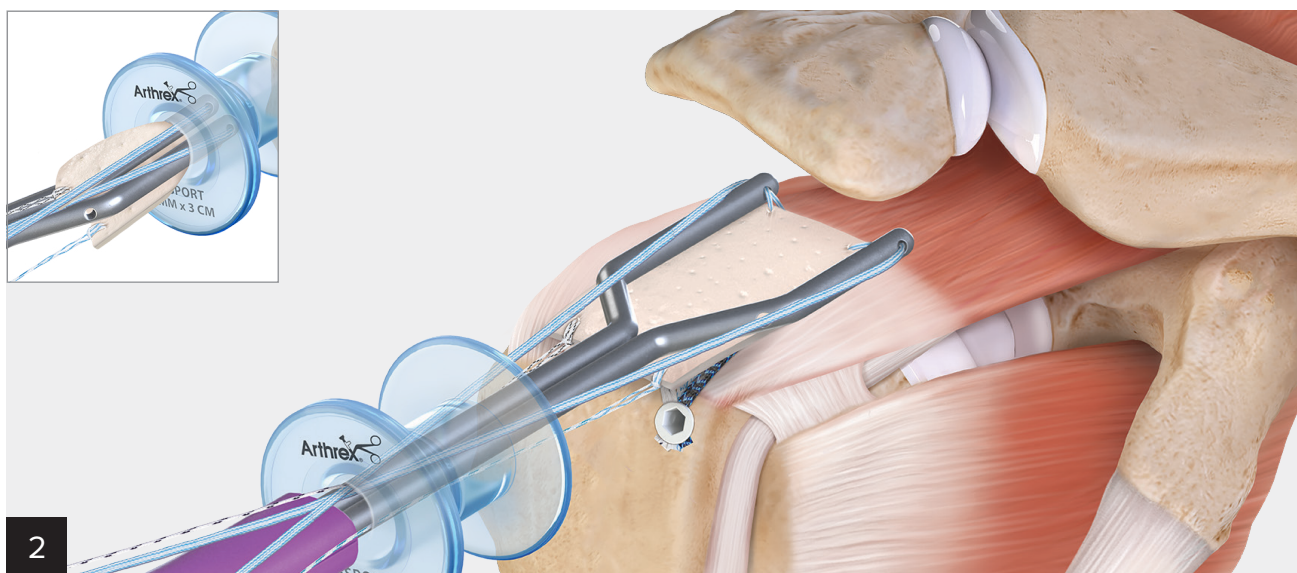

Introduce the retracted graft spreader through the lateral PassPort Button™ cannula. Once completely introduced into the subacromial space, open the articulating arm by sliding the button on the handle toward the tip of the device, spreading the graft over the desired location on the rotator cuff. Note that the left arm of the graft spreader is the articulating arm, and the right arm is fixed.

Note: The graft spreader will fit best through a 10 mm diameter PassPort Button cannula or larger.

Medial Graft Fixation

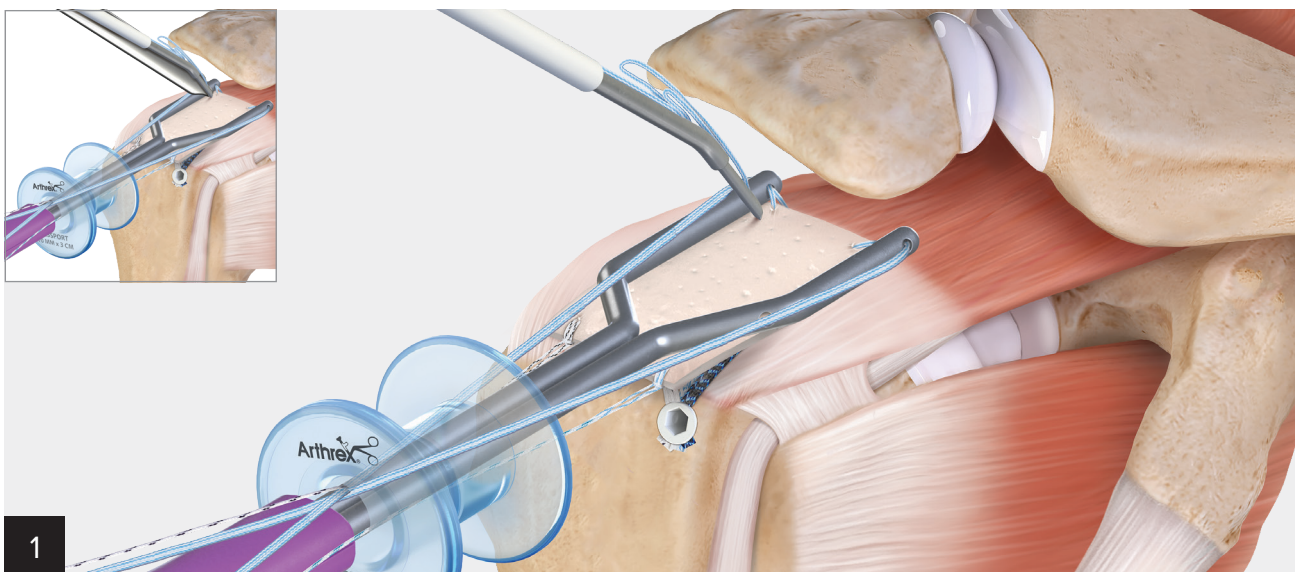

Introduce the FiberStitch™ RC 1.5 device into the subacromial space, targeting the medial edge of the graft.

Optional: a cannula or portal skid may be used to help with introduction of the device (top-left).

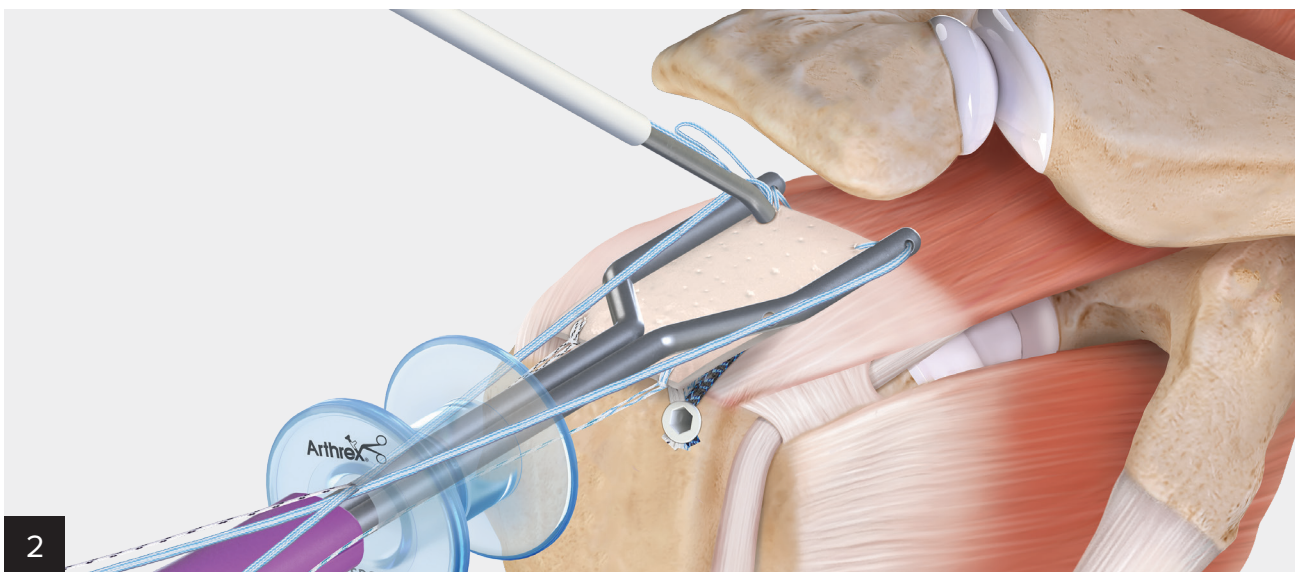

Insert the delivery needle through the graft and cuff until the depth stop is flush with the graft, taking care to not prematurely deploy the implant. Once the device is in the desired location, roll the deployment wheel backward until a hard stop is felt and an audible click is heard. This will deploy the first implant. Roll the wheel forward until a hard stop is felt and an audible click is heard. This will confirm the first implant has been deployed. If there is resistance to move the wheel during deployment, the needle may be against a bony surface. Try to move slightly to free up space for the implant to deploy.

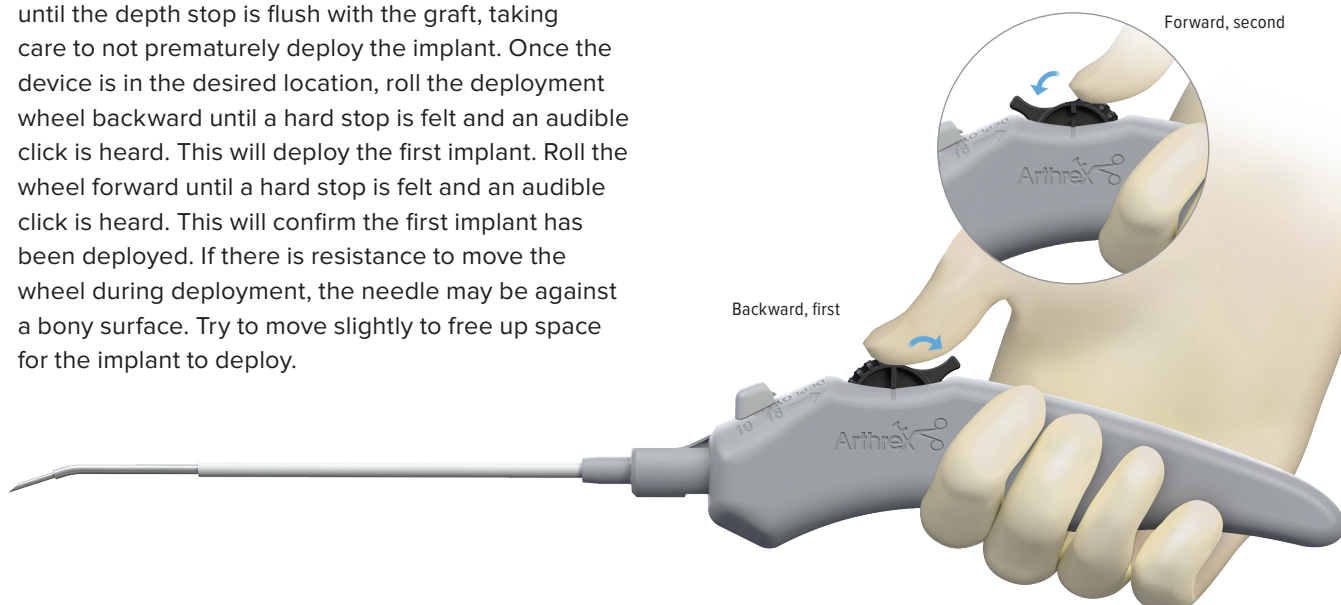

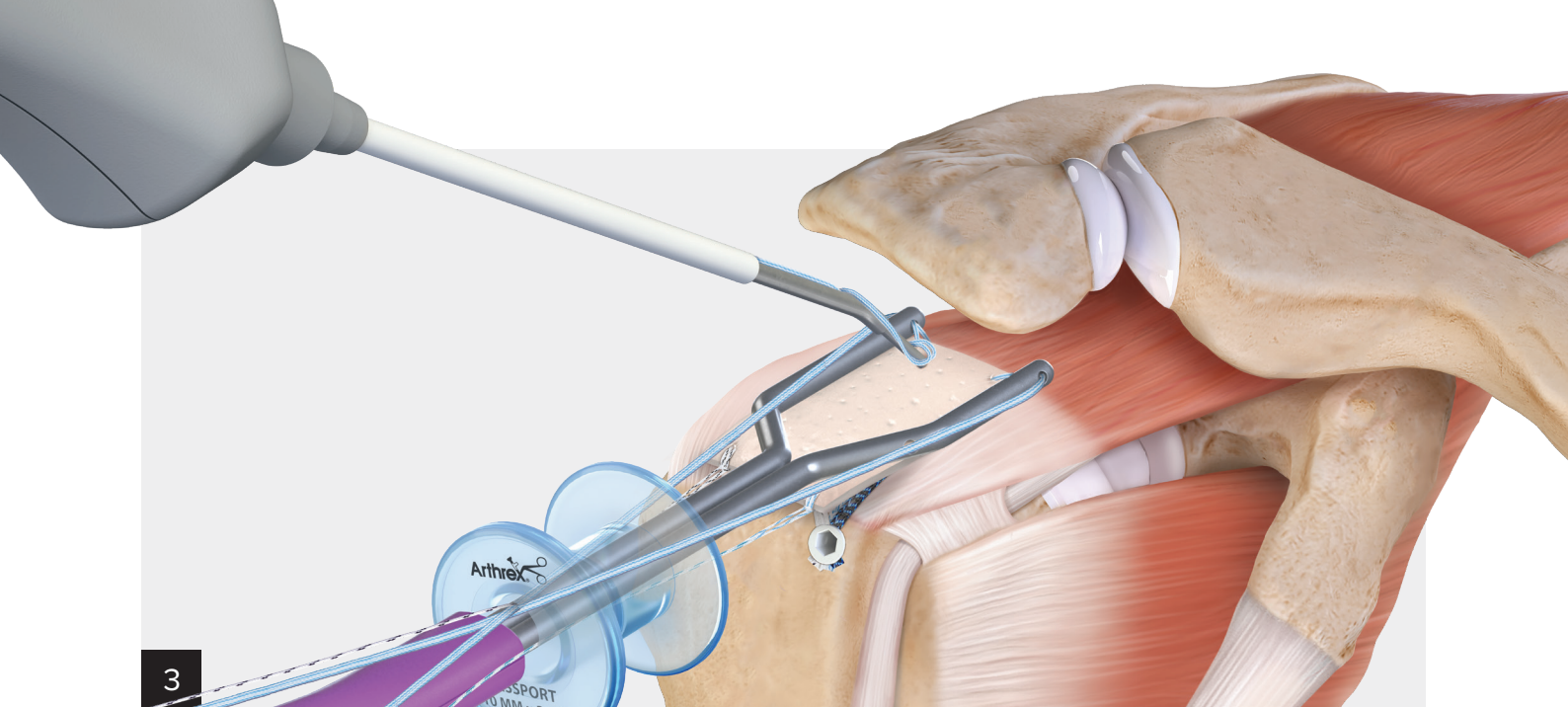

While keeping the tip of the device in the subacromial space, remove the delivery needle from the graft, and move to desired location of second implant, creating a mattress stitch. Advance the needle through the graft and cuff again. Once the device is in the desired location, roll the deployment wheel backward until a hard stop is felt and an audible click is heard. This will deploy the second implant. Roll the wheel forward until a hard stop is felt and an audible click is heard. This will confirm the second implant has been deployed.

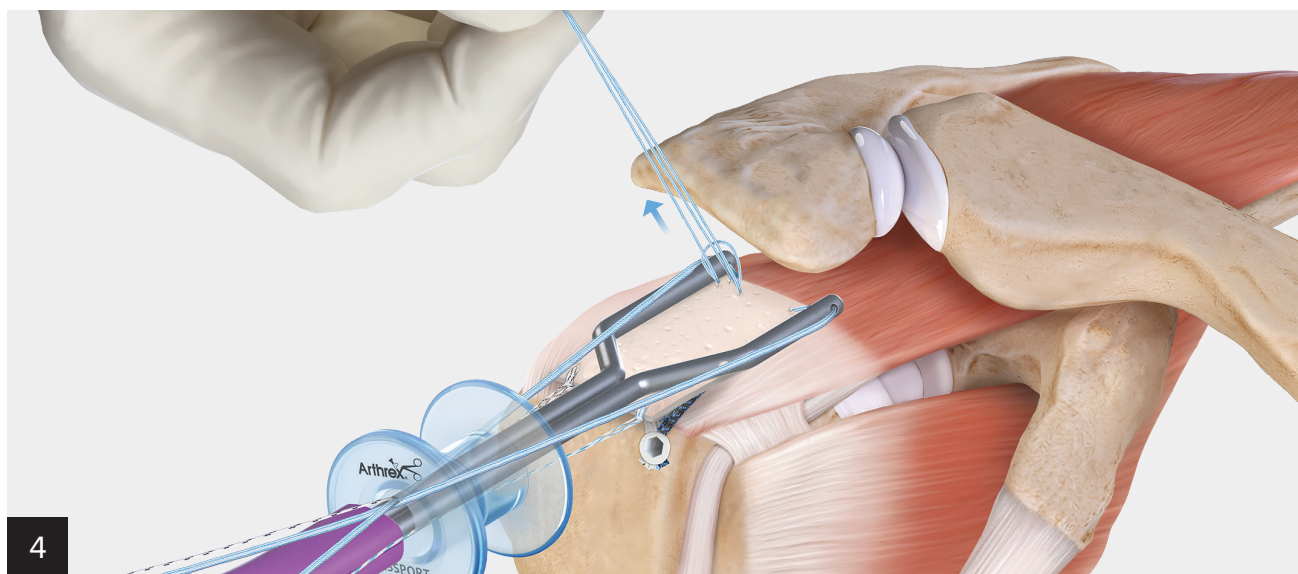

Once both implants are deployed and the inserter is removed from the subacromial space, pinch all the sutures and gently pull to set the implants.

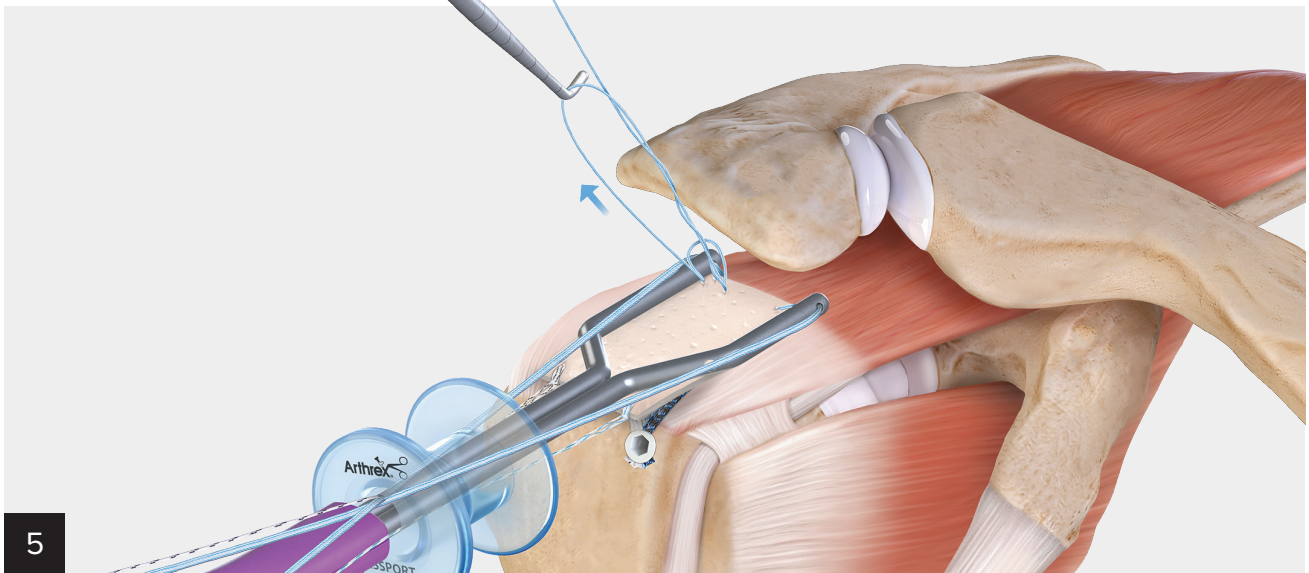

A suture loop and single suture will be visible outside the shoulder. Insert a probe or similar device through the loop and pull the loop of suture to reduce the suture spanning the two implants.

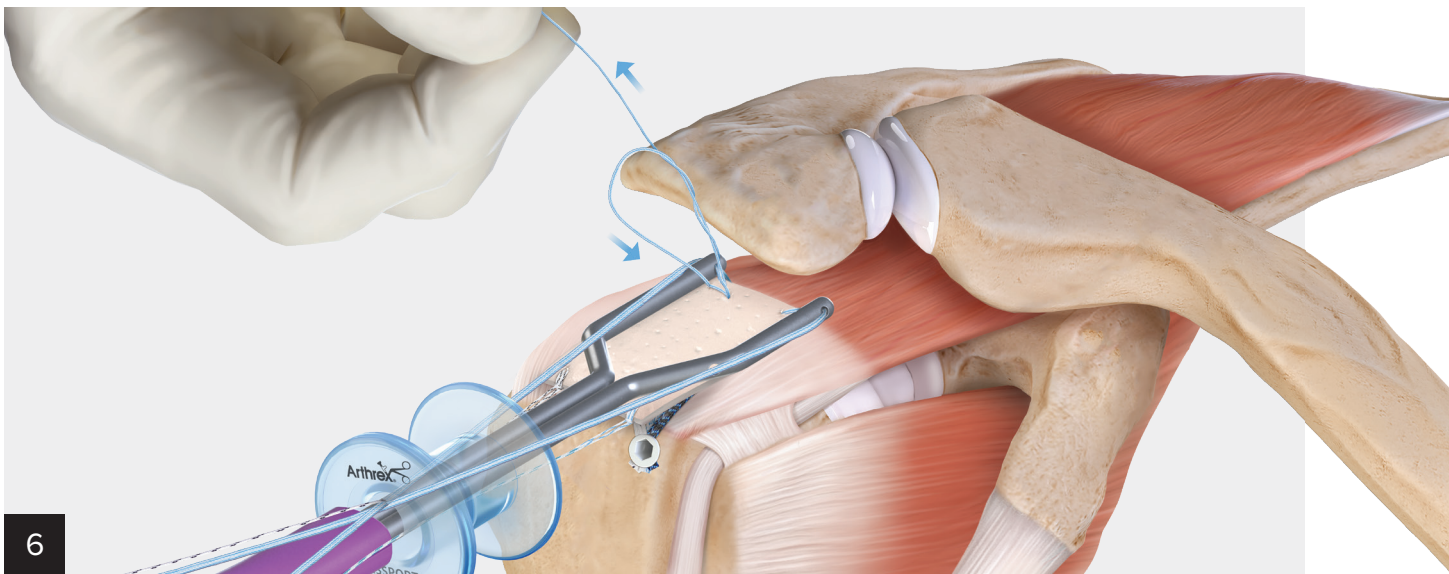

Tension the single suture to reduce the suture loop. The implants are secured when the loop is reduced creating a mattress stitch configuration.



7

Load the tail of the suture into the loading wire and pull the tab to load the knot pusher.

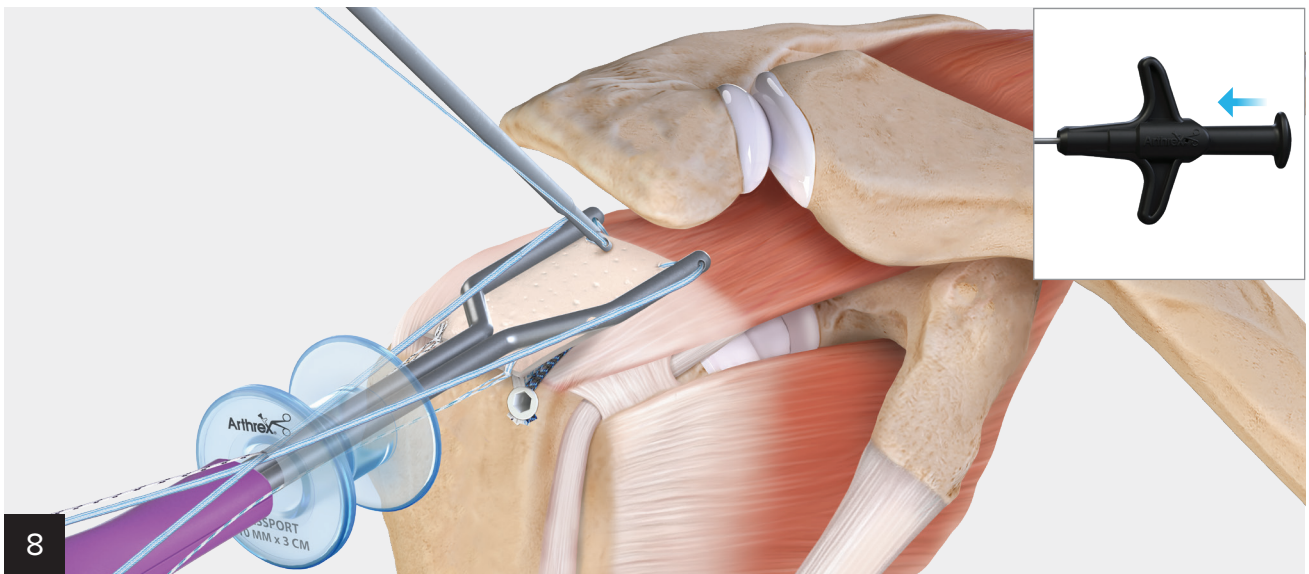

8

Advance the knot pusher toward the graft, keeping it parallel to the suture while maintaining tension on the suture. Be careful not to cut the suture prematurely. Depress the plunger to cut the suture.

Note: it is recommended to leave a few mm of suture tail before cutting.

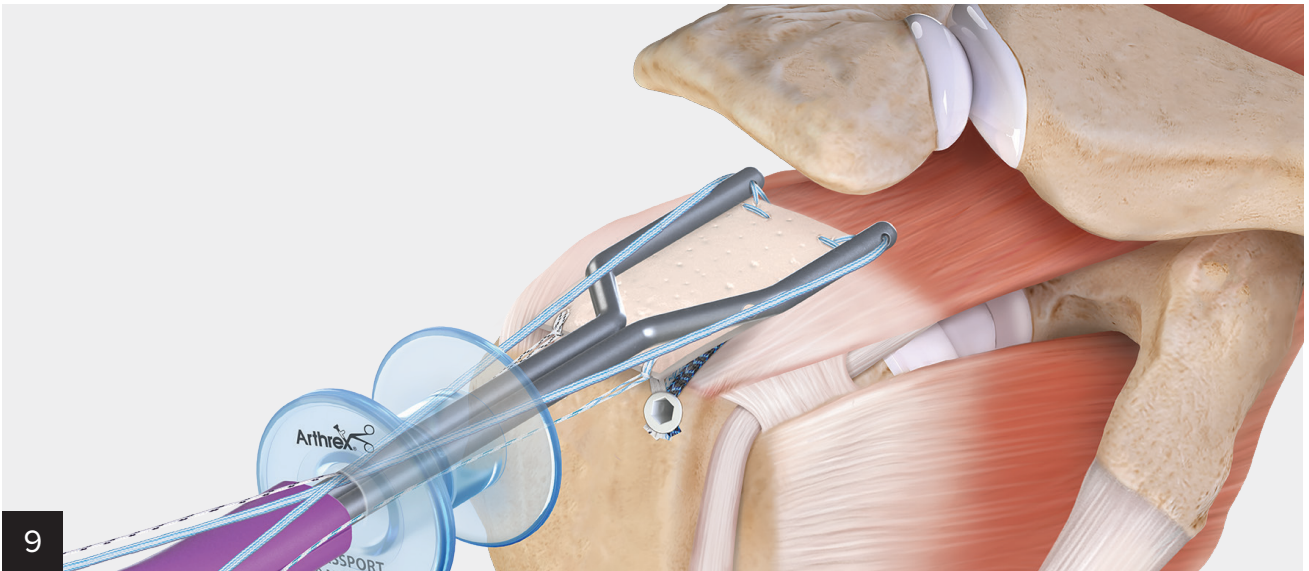

Repeat steps 1-8 to complete medial fixation on the opposite corner of the graft.

Graft Spreader Removal

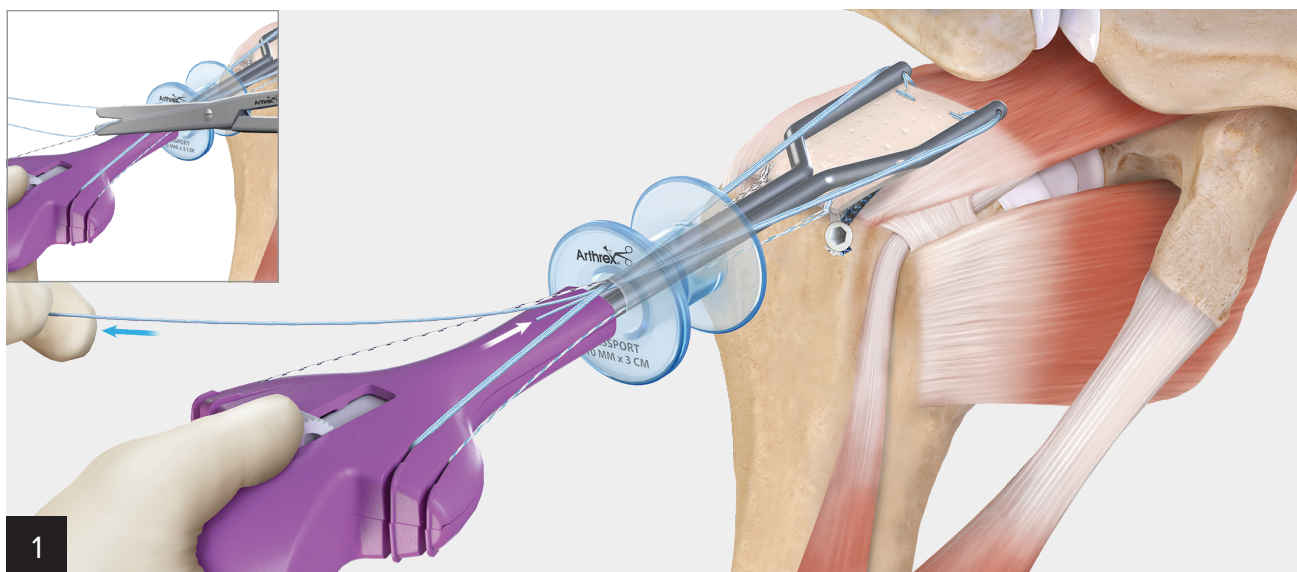

While holding the graft spreader in place, unclasp and remove the #0 FiberWire® sutures. Pull on one suture limb to remove it from the graft and graft spreader. Repeat on the other side.

Note: It may be helpful to cut one limb of the FiberWire suture close to the PassPort Button cannula to reduce the friction of suture to remove.

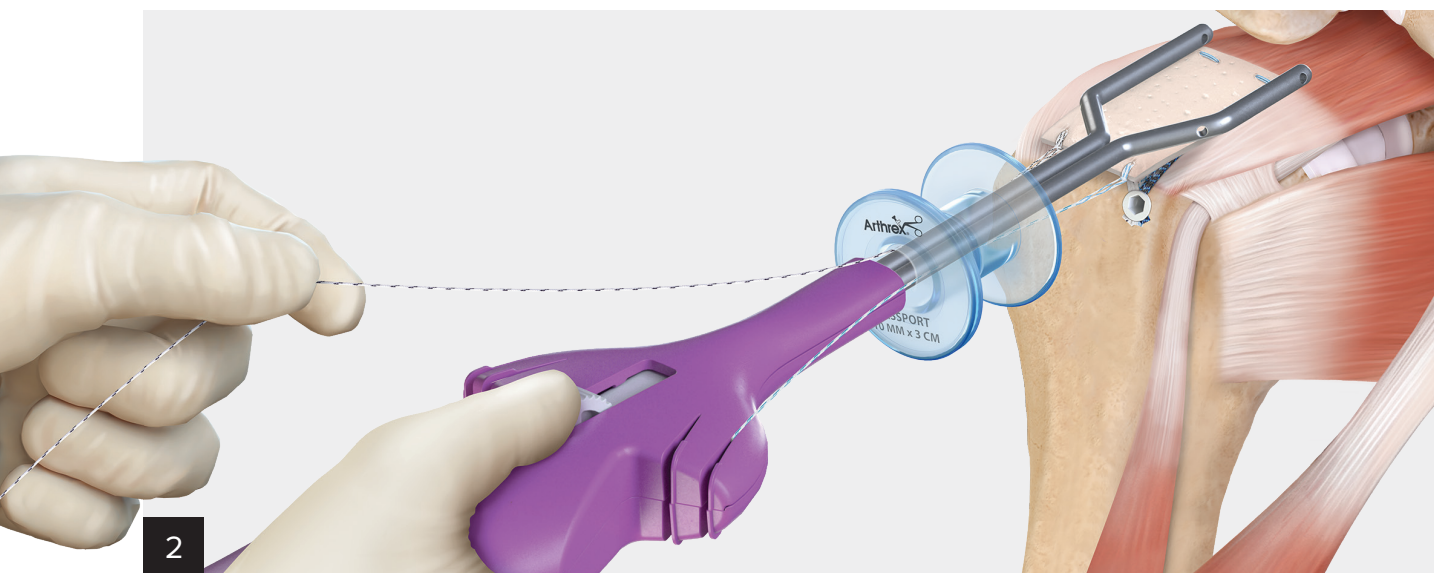

Unclasp the remaining lateral sutures from the graft spreader handle. Retract the arm by sliding the button backwards and carefully remove the graft spreader from the cannula.

Lateral Graft Fixation

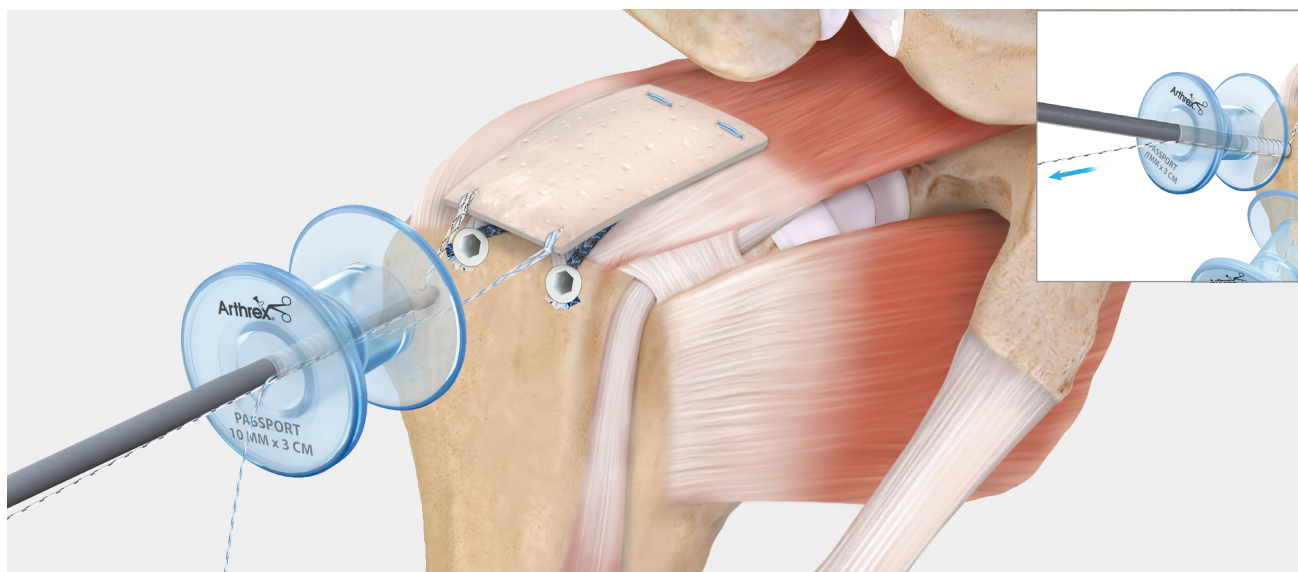

Load one of the lateral SutureTapes through the eyelet of the 3.5 mm self-punching PushLock® anchor. Taking care to avoid the existing lateral row anchors from the SpeedBridge™ repair construct, introduce the PushLock® anchor through the lateral portal and insert the anchor. Repeat this step for the remaining lateral anchor.

Note: Take care to not over-tension the suture and graft.

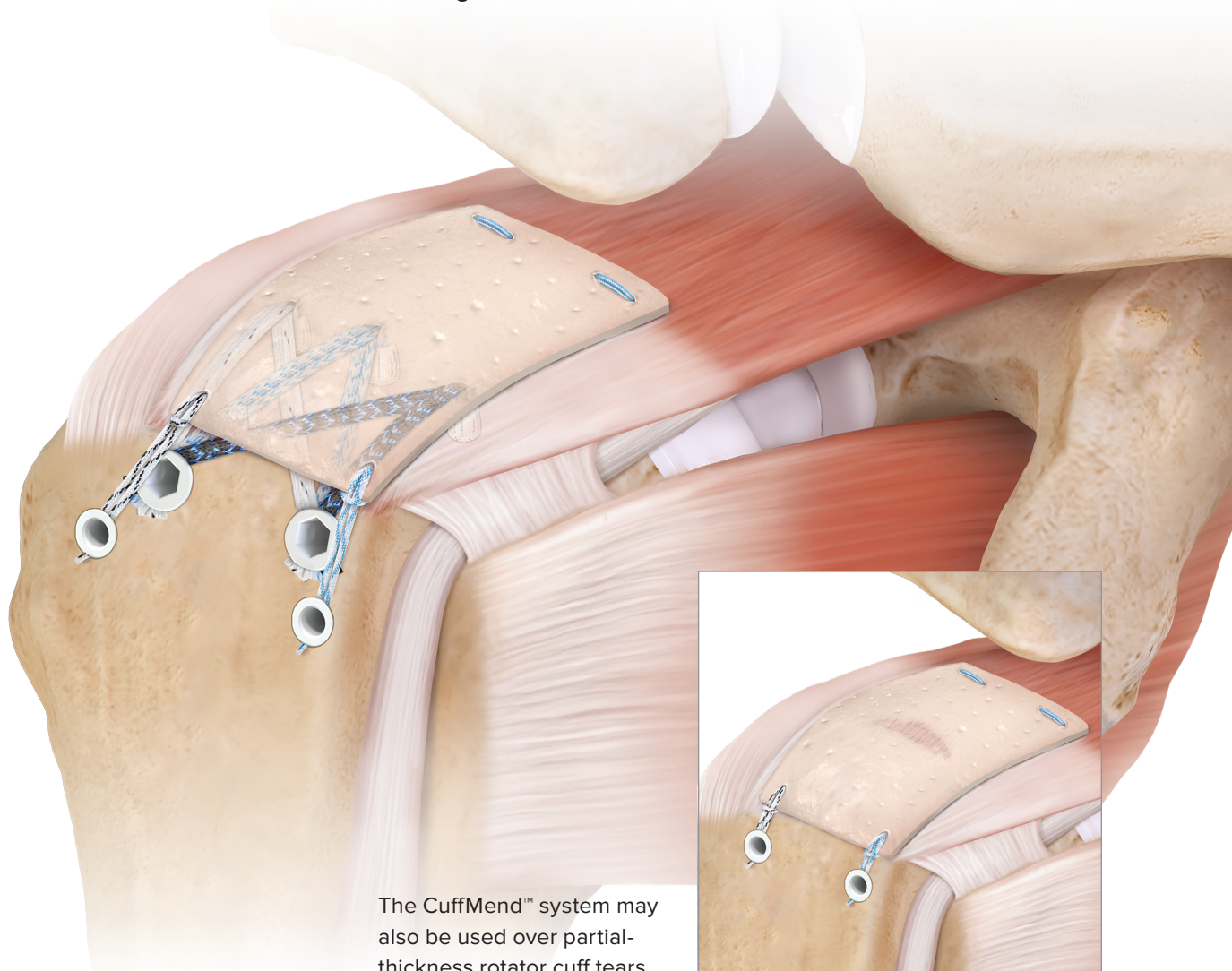

The CuffMend™ system may also be used over partial-thickness rotator cuff tears

Posterior Approach for CuffMend™ Rotator Cuff Augmentation

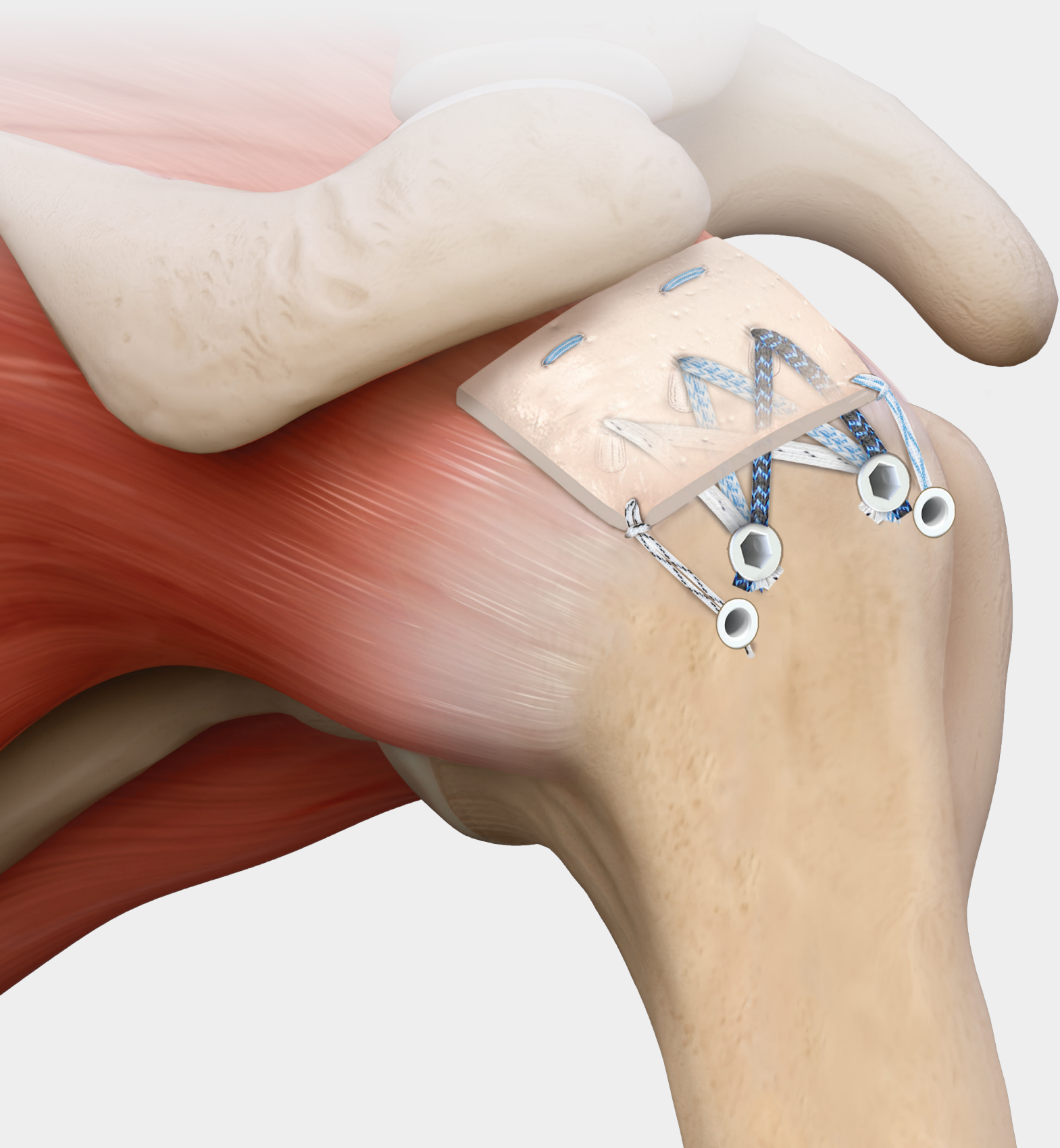

Portal Placement

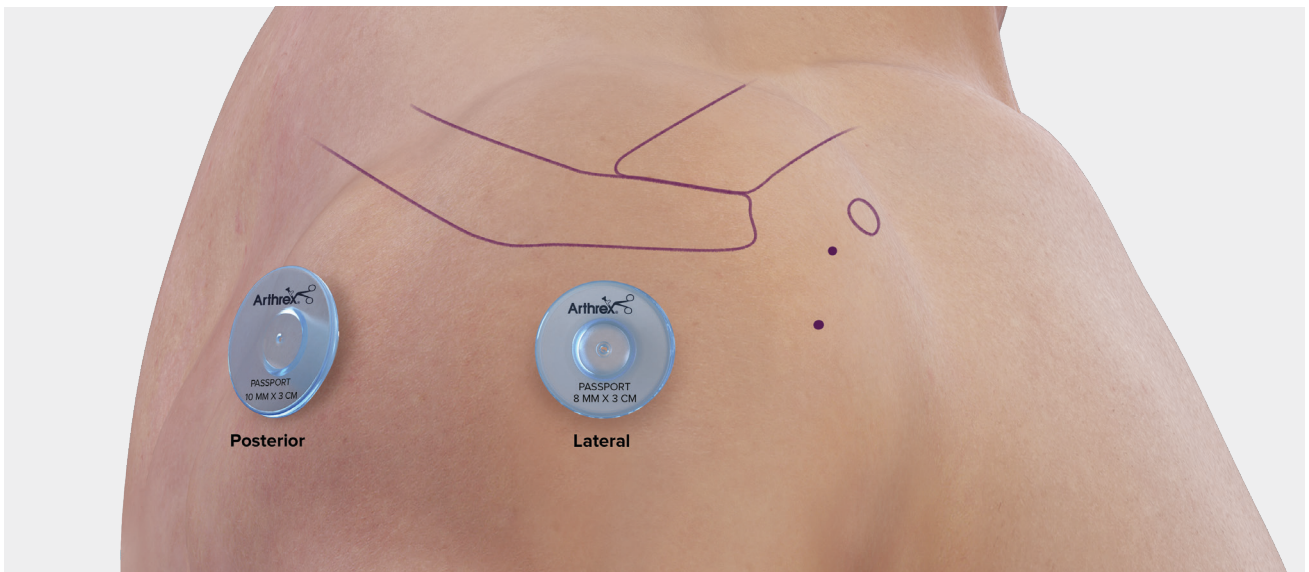

A 10 mm or larger PassPort Button™ cannula can be placed posteriorly for introduction of the graft spreader. Another PassPort Button cannula can be inserted laterally to be used for viewing, as well as for insertion of PushLock® anchors.



Graft Sizing

Insert the graft spreader into the subacromial space, and roll the wheel back to deploy. The arm of the graft spreader from the tip to the first bend is approximately 31 mm. Use this approximate measurement as a reference for choosing the appropriately sized ArthroFlex precut graft.

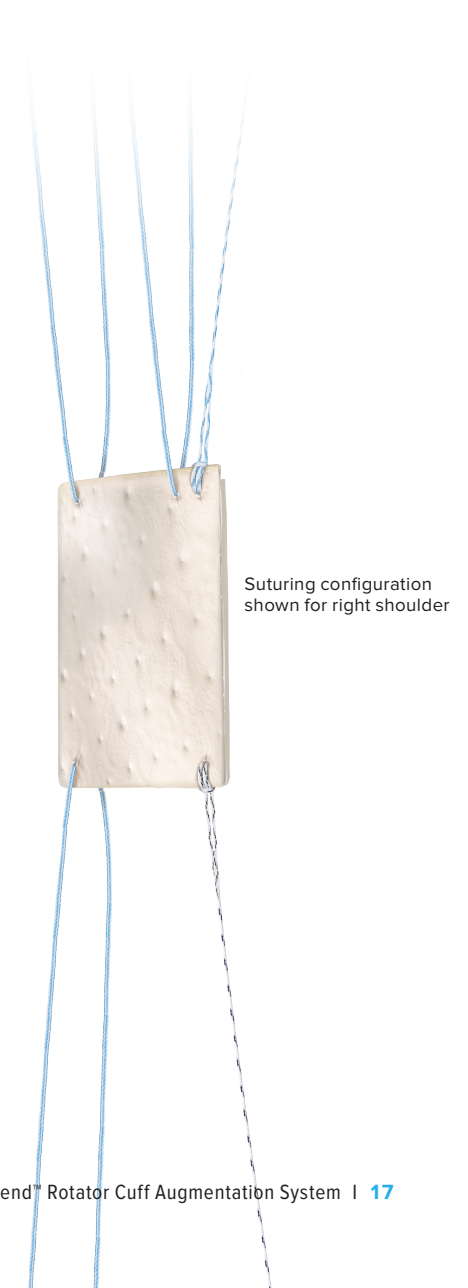

Graft Preparation for Posterior Approach with ArthroFLEX® Human Dermal Allograft

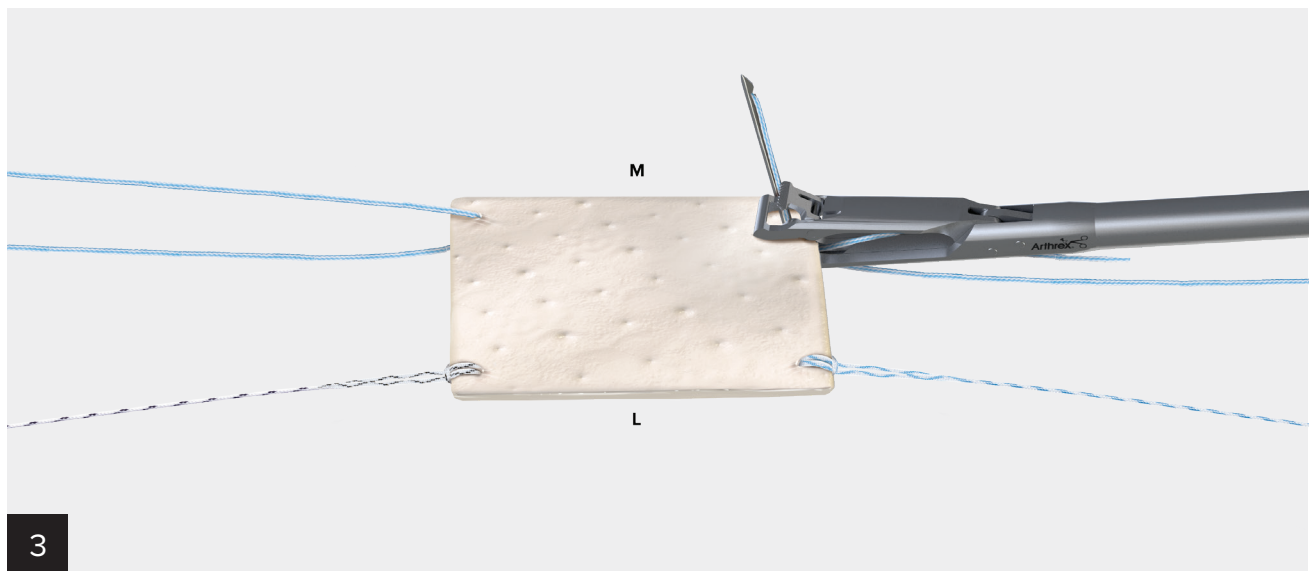
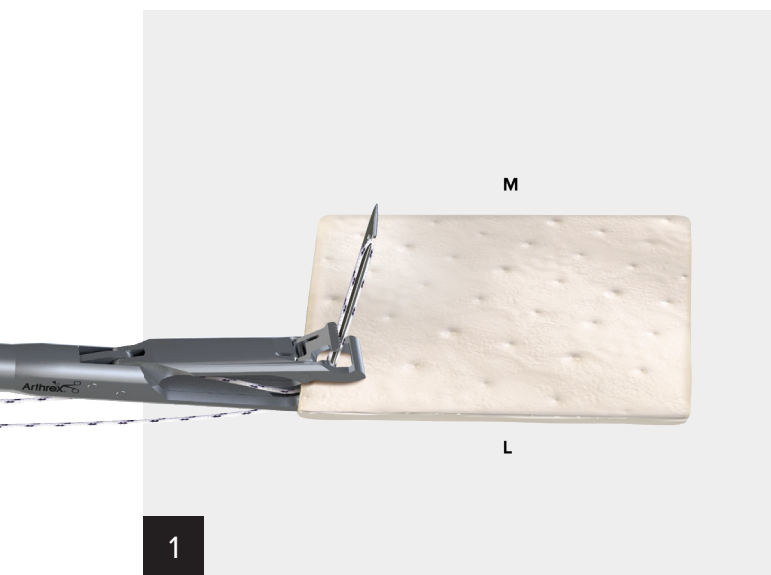

Using a Scorpion™ suture passer, place a 0.9 TigerLink™ SutureTape and a 0.9 FiberLink™ SutureTape into the lateral corners of the ArthroFlex dermal allograft in a cinch stitch configuration. Prepare the medial corners of the graft by passing a #0 FiberWire® suture in a simple pass configuration.

Add an additional #0 FiberWire suture to the anterolateral corner of the graft.

Note: Orientation of the graft is different for a left shoulder case vs a right shoulder case. The extra #0 FiberWire suture will always go into the anterolateral corner of the graft.

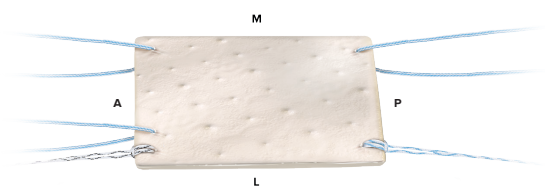

Left Shoulder Suture Configuration

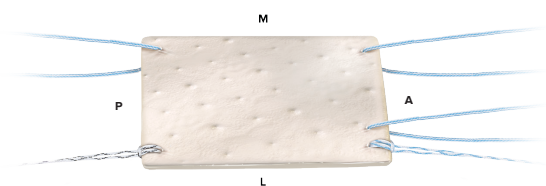

Right Shoulder Suture Configuration

Graft Spreader Loading for Left Shoulder

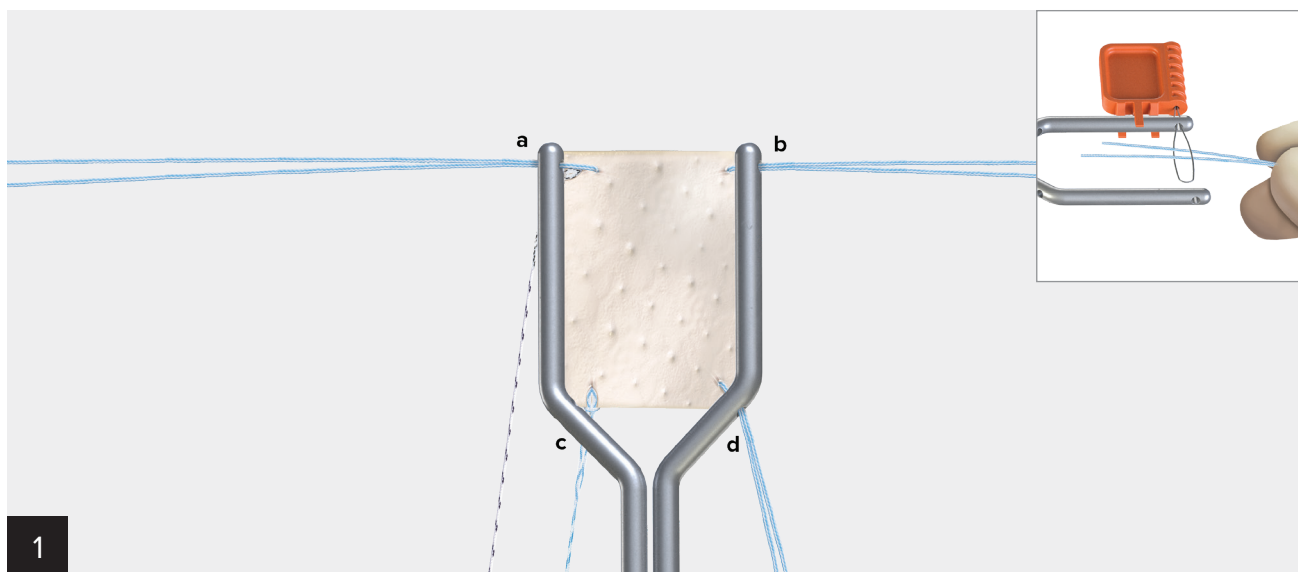

Using the suture passing flag, load all the #0 FiberWire® sutures through the holes on the graft spreader (a, b, d).

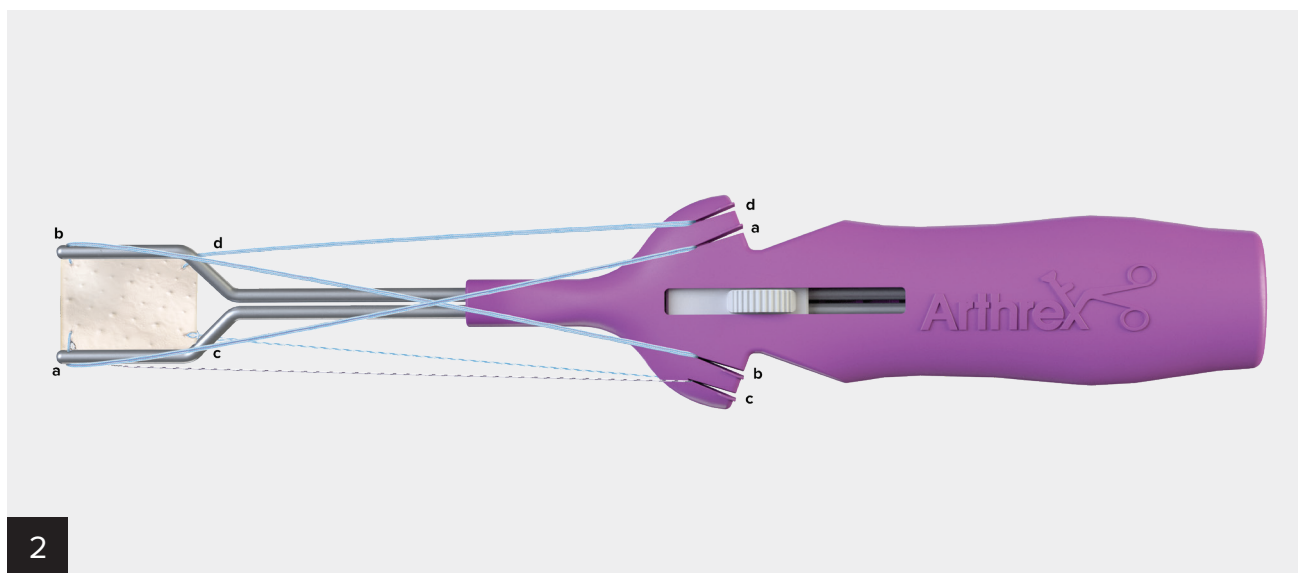

Cleat the #0 FiberWire sutures (a,b) in a crisscross pattern to the inside cleats of the graft spreader handle. Cleat the #0 FiberWire suture from corner (d) into (d) on the same side of the graft spreader handle. Cleat both the FiberLink™ and TigerLink™ SutureTapes into (c) on the graft spreader handle.

Graft Spreader Loading for Right Shoulder

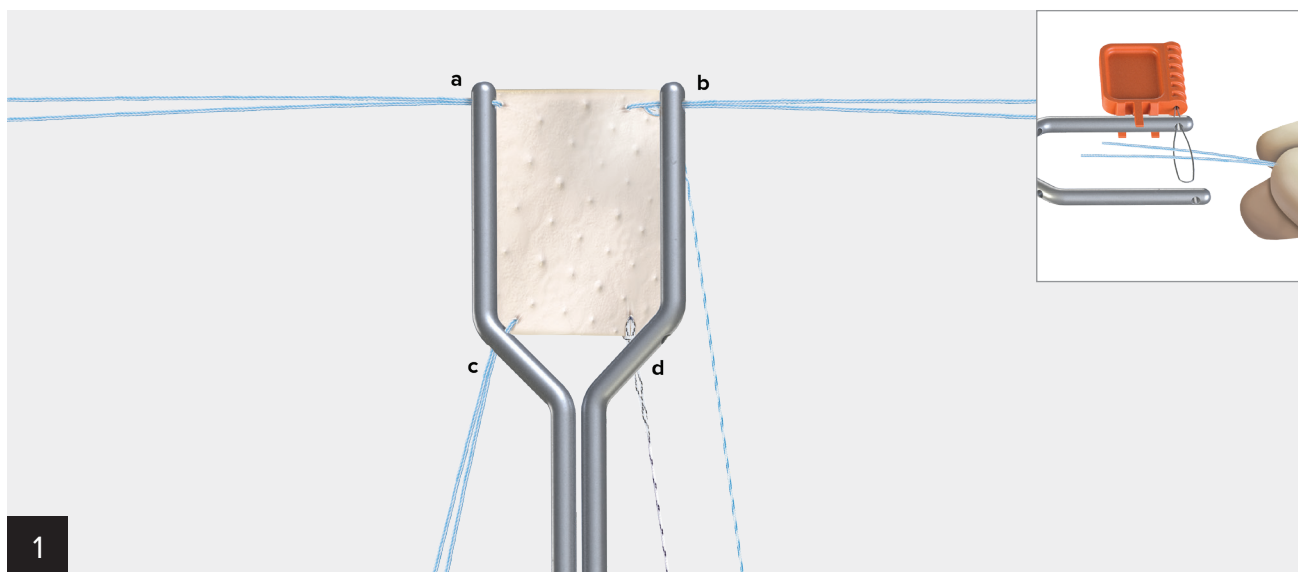

Using the suture passing flag, load all the #0 FiberWire® sutures through the holes on the graft spreader (a, b, c).

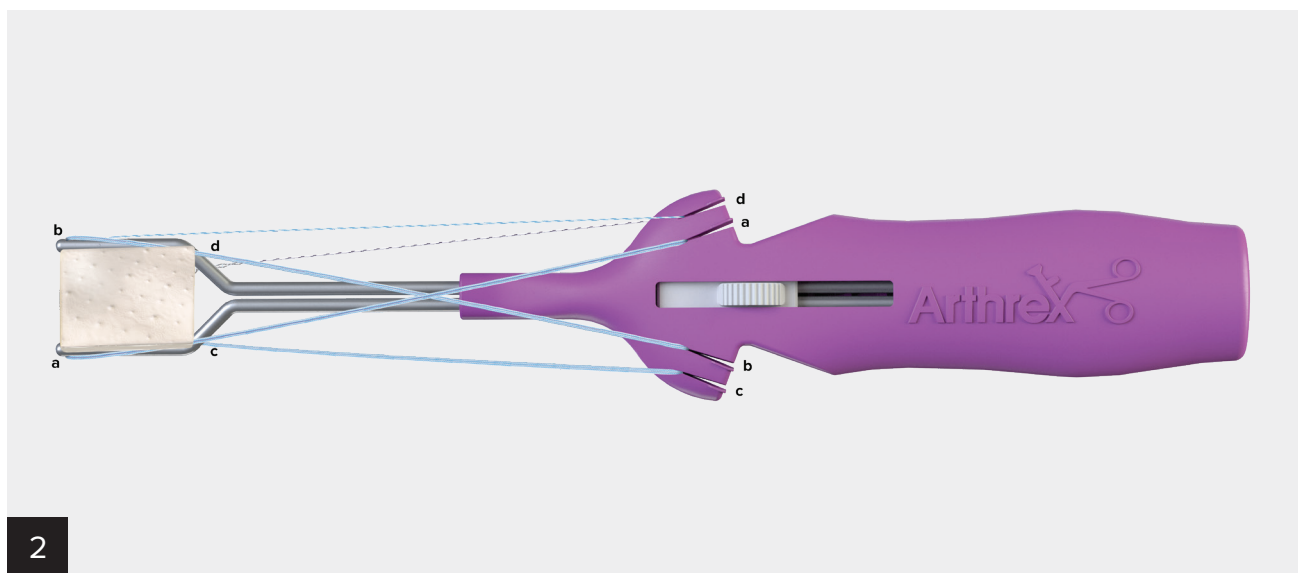

Cleat the #0 FiberWire sutures (a,b) in a crisscross pattern to the inside cleats of the graft spreader handle. Cleat the #0 FiberWire suture from corner (c) into (c) on the same side of the graft spreader handle. Cleat both the FiberLink™ and TigerLink™ SutureTapes into (d) on the graft spreader handle.

Graft Delivery for Right Shoulder

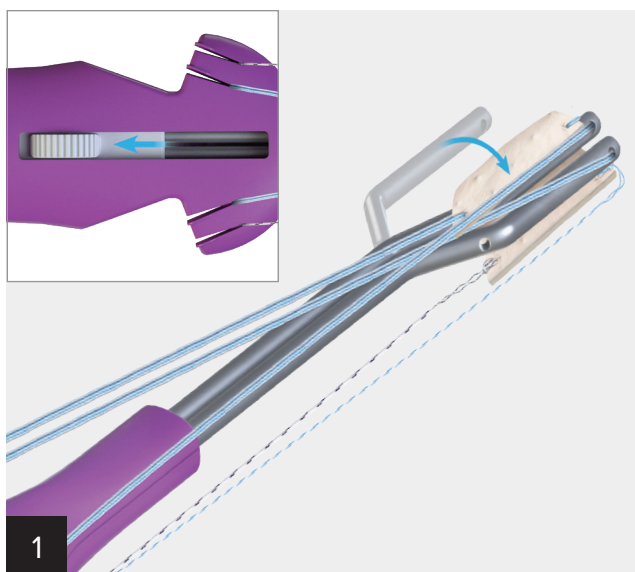

Once the graft is loaded onto the graft spreader, retract the articulating arm by sliding the button backward.

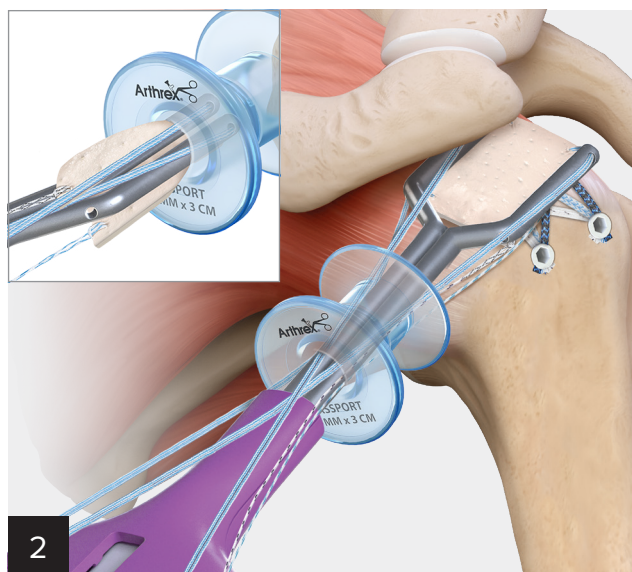

Introduce the retracted graft spreader through the posterior PassPort Button™ cannula. Once completely introduced into the subacromial space, open the articulating arm by sliding the button on the handle toward the tip of the device, spreading the graft over the desired location on the rotator cuff.

Note: The graft spreader will only fit through a 10 mm diameter PassPort Button cannula or larger.

Medial Graft Fixation

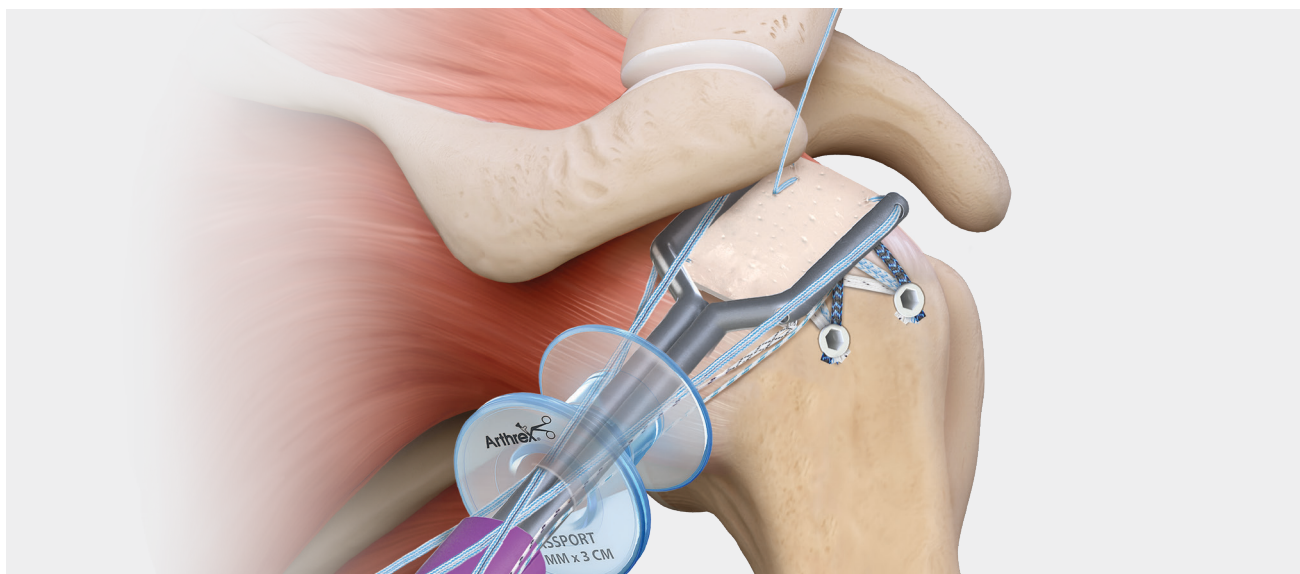

Fixate the medial edge of the graft using FiberStitch™ RC 1.5. For full details on use of FiberStitch RC 1.5, see pages 9-13.

Graft Spreader Removal

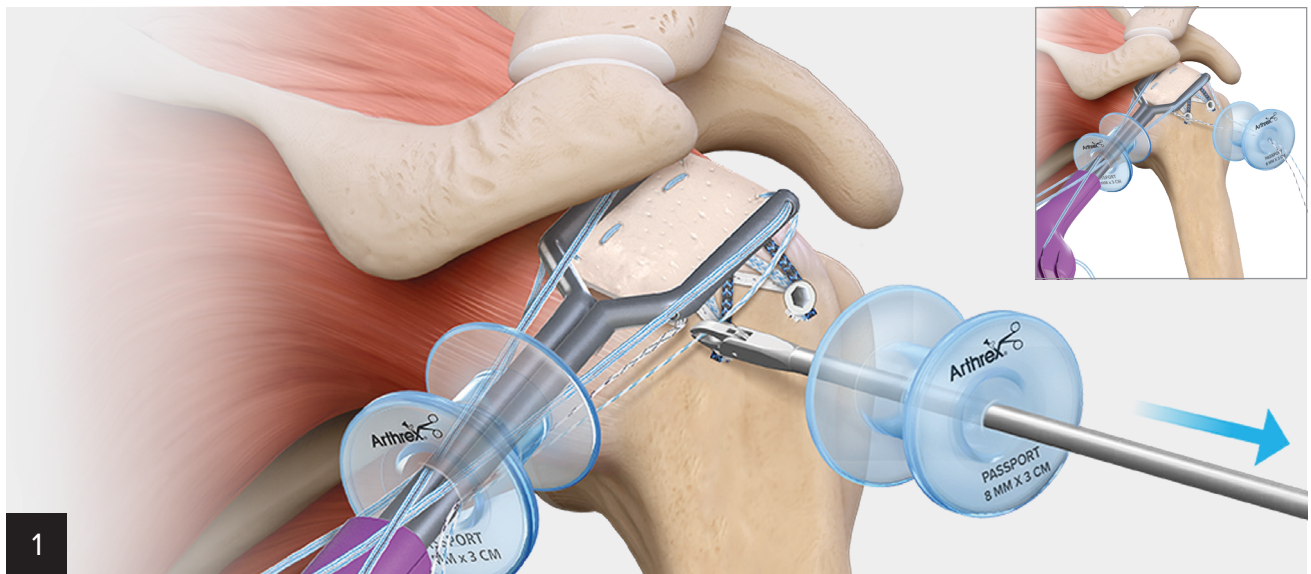

While holding onto the graft spreader, uncleat the FiberLink™ SutureTape and TigerLink™ SutureTape. Retrieve the sutures out of the lateral portal.

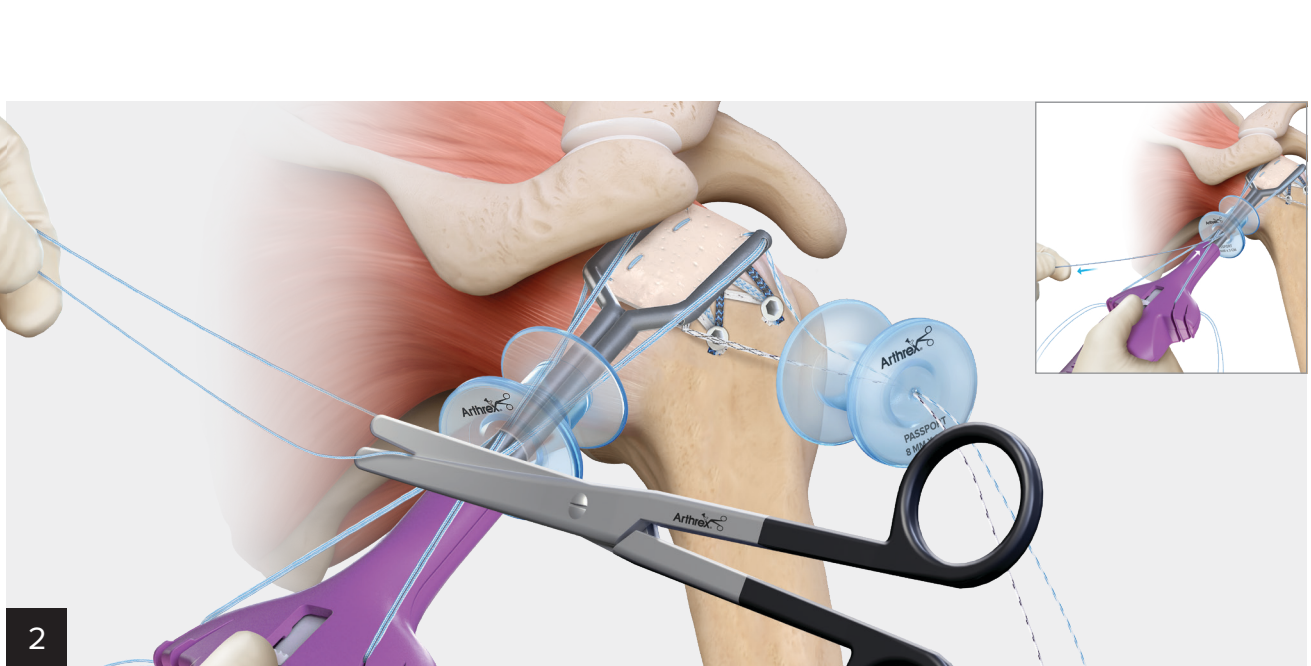

Uncleat the remaining sutures from the graft spreader handle (see inset). Retract the arm by sliding the button backwards and carefully remove the graft spreader from the cannula.

Lateral Graft Fixation

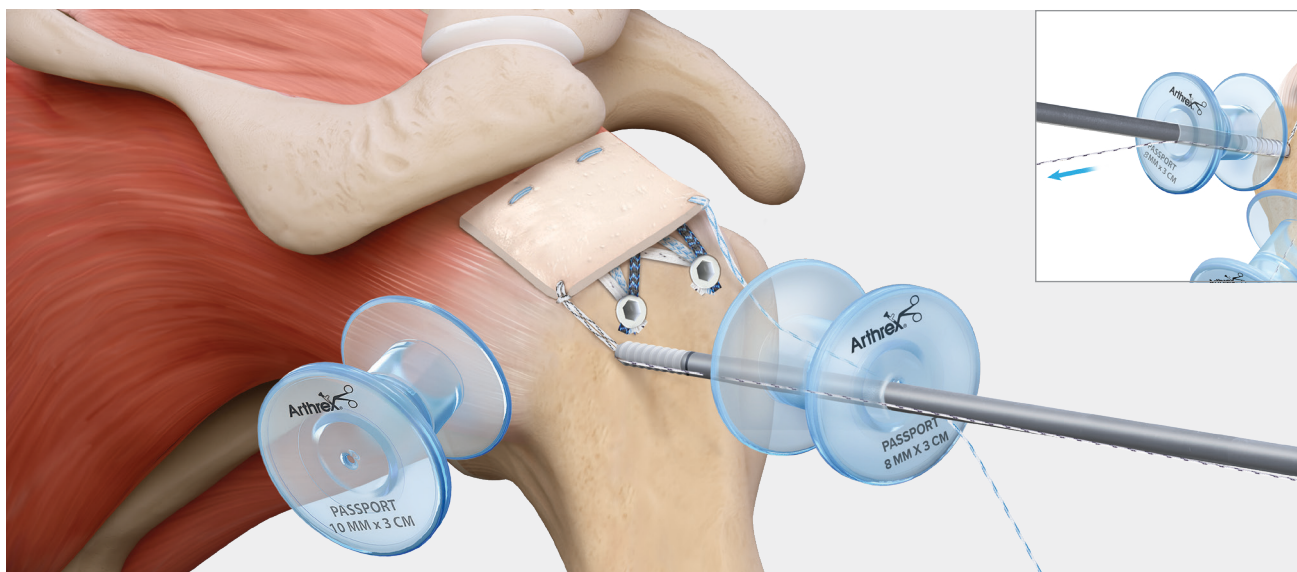

Load a lateral 0.9 mm FiberLink™ or TigerLink™ SutureTape through the eyelet of the 3.5 mm self-punching PushLock® anchor. Taking care to avoid the existing lateral row anchors from the Speedbridge repair construct, introduce the PushLock anchor through the lateral portal and insert the anchor. Repeat this step for the remaining lateral anchor.

Note: Take care to not over-tension the suture and graft.

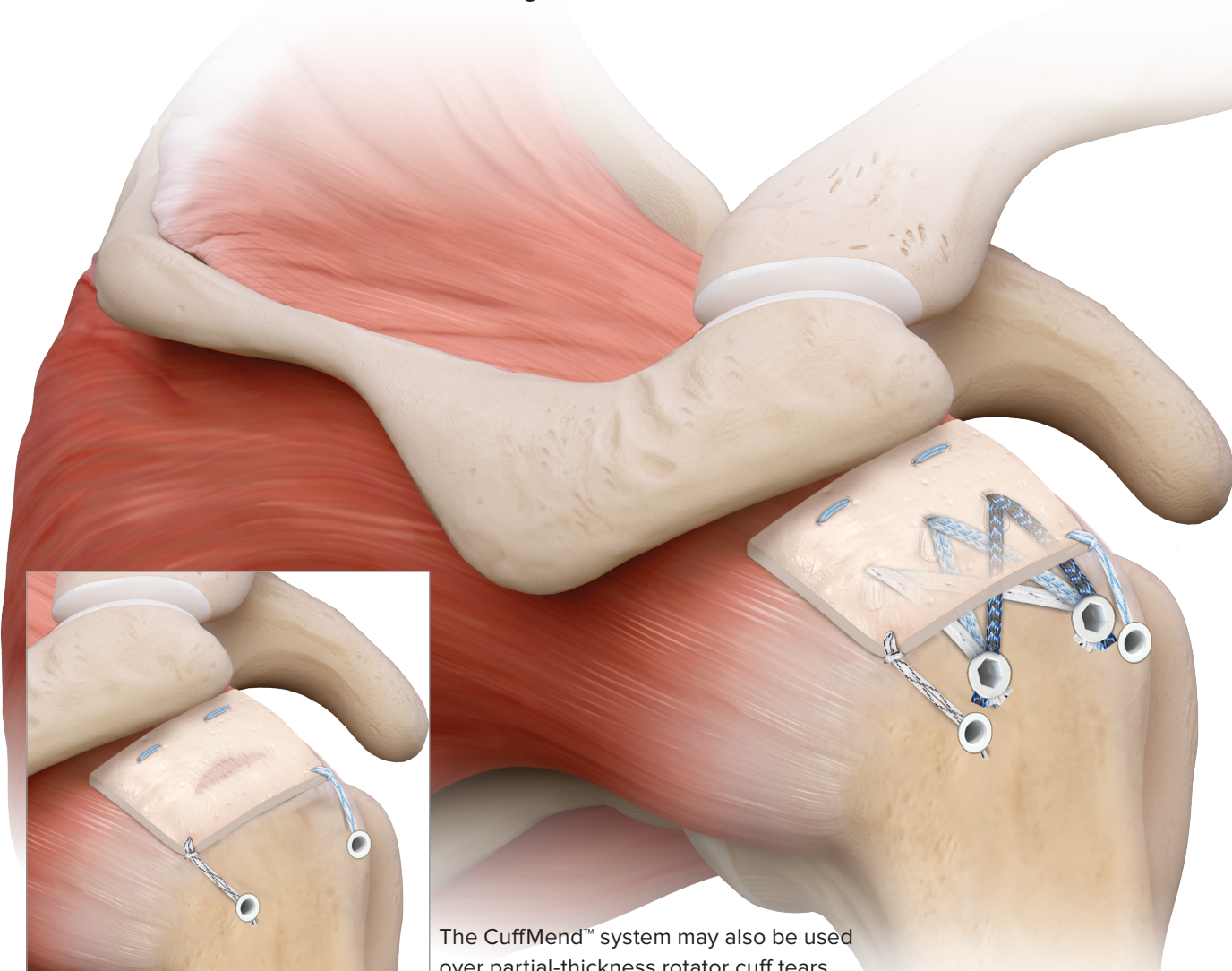

The CuffMend™ system may also be used over partial-thickness rotator cuff tears.

Auto CuffMend™ Rotator Cuff Augmentation

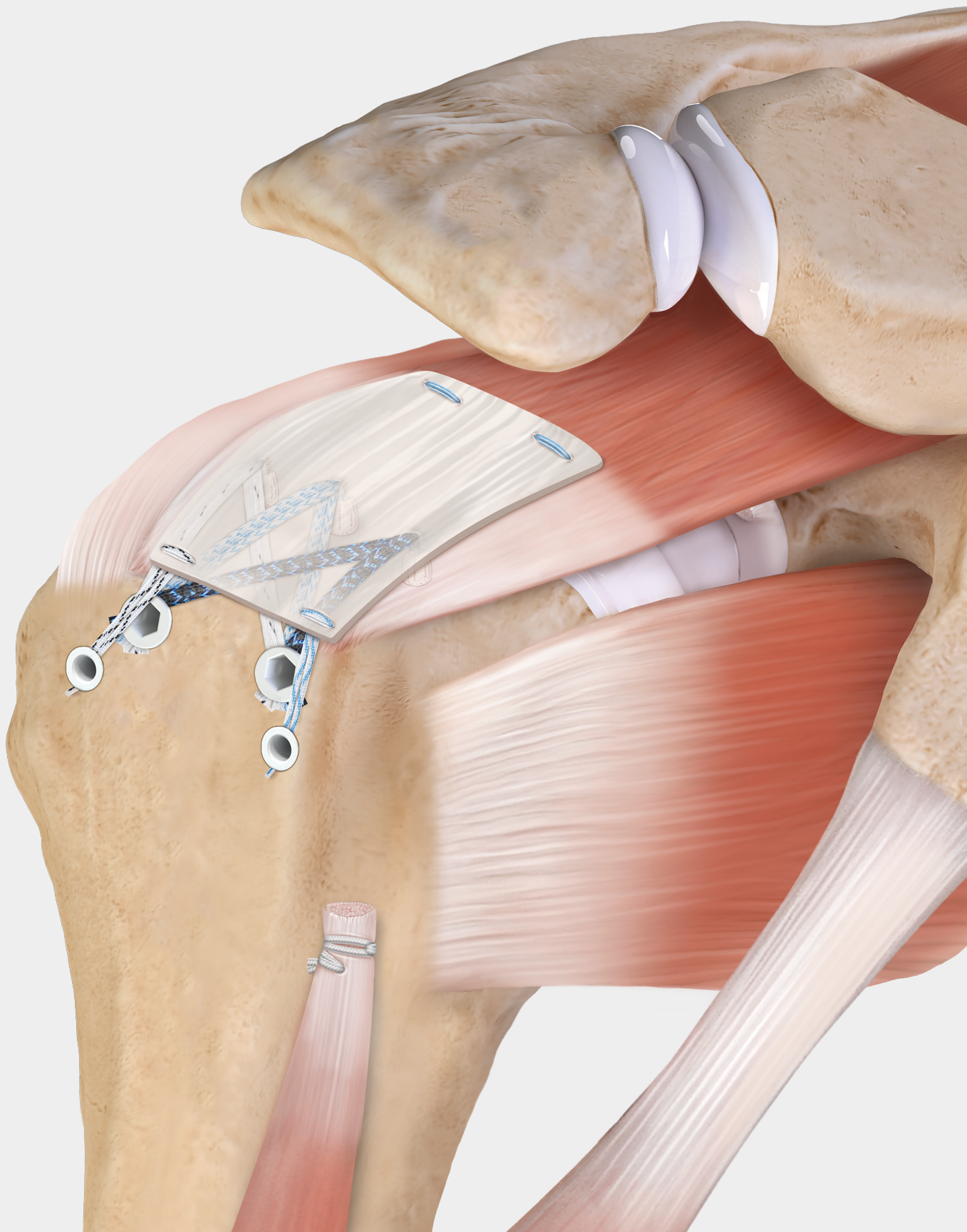

Autograft Tissue Compression System

The Autograft Tissue Compression System is designed to create a graft using autologous tissue, such as biceps tendon. The graft can be used for CuffMend rotator cuff augmentation.

The Autograft Tissue Compression System consists of a press and disposable plates. Holes in the plates can be used to help suture the graft.

Graft Preparation

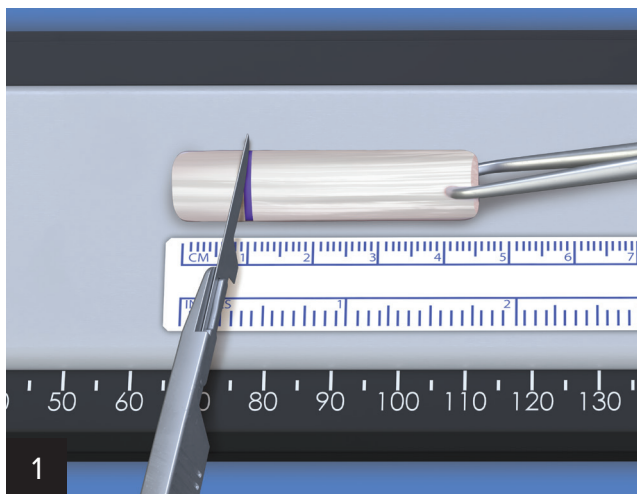

Harvest the proximal biceps tendon. It is recommended to use mechanical cutting instead of RF to prevent tissue necrosis. Remove 1 cm from the labral attachment end of the harvested tendon. Trim the remaining graft to 27 mm in length.

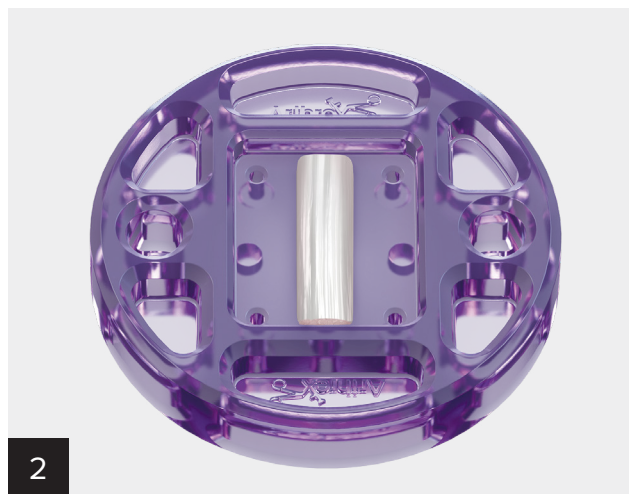

Place the biceps tendon into the center of the bottom plate's recess to ensure even graft spreading during compression.

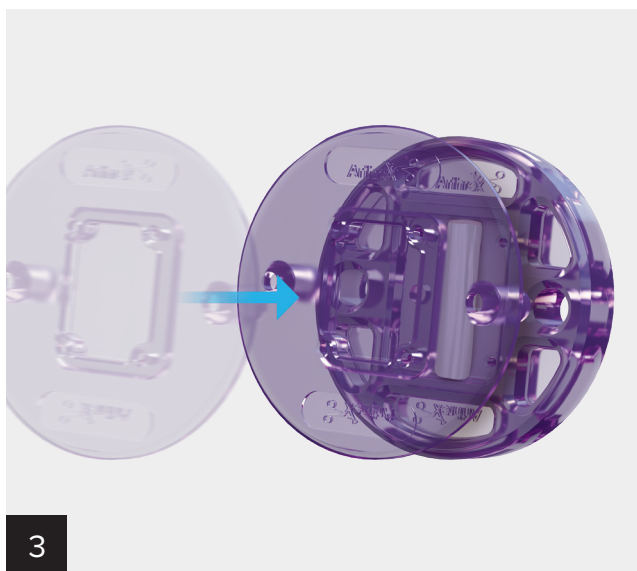

Place the top plate over the bottom plate by aligning the pins.



Load the plates onto the press and twist them to lock in place. Turn the press handle clockwise until the indicator line is close to MAX. Allow a minimum of 4 minutes of compression before removing the plates.

Unscrew the press handle to remove and separate the plates. The compressed biceps graft will be approximately 27 mm × 22 mm.

Graft Preparation for Lateral Approach

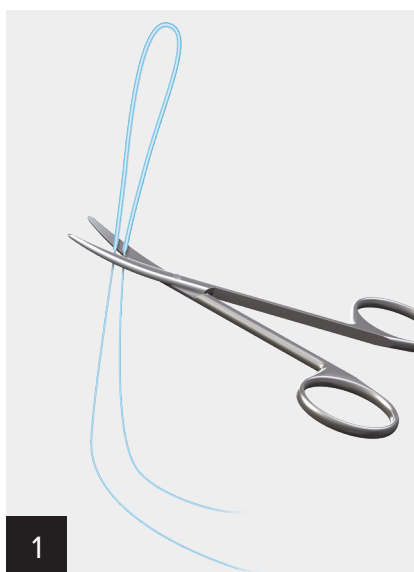

For medial suture passing on the biceps graft, cut off the thick portion of the FiberLoop® suture, separating the tails.

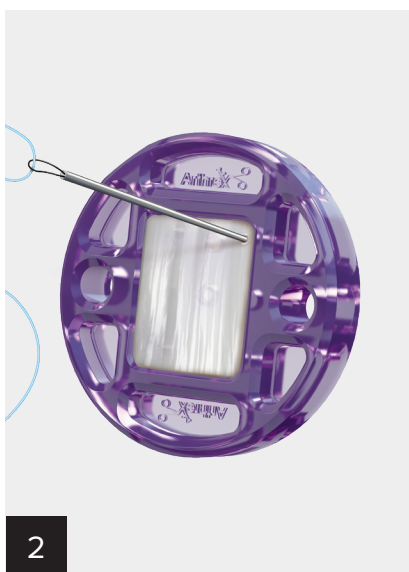

Pass the FiberLoop needle through a medial corner of the graft and continue through the corresponding hole on the plate. Pull the suture about halfway through.

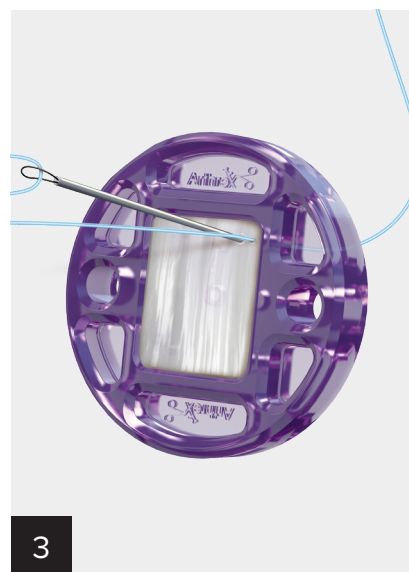

Remove the needle and thread the unpassed suture tail into the needle loop. Pass the needle through the same medial corner of the graft and the hole in the plate to make a mattress configuration. Pull the suture tails even.



With a new FiberLoop suture, repeat the same mattress suture on the other medial corner of the graft.



Thread the needle onto a TigerLink™ or FiberLink™ SutureTape. Pass the needle from top to bottom through a lateral corner of the graft and plate. Pull the suture about halfway through.

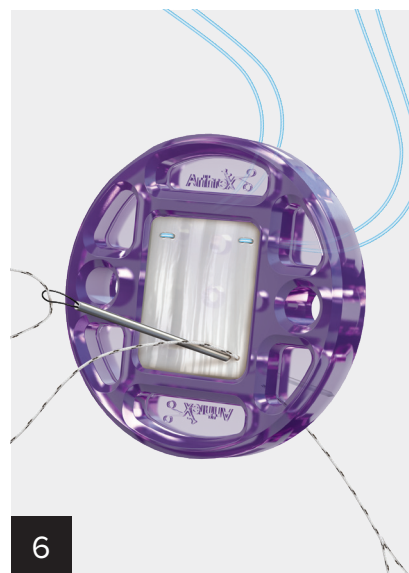

Rethread the needle onto the loop end of the suture and pass it back through the graft and plate to complete a mattress stitch.

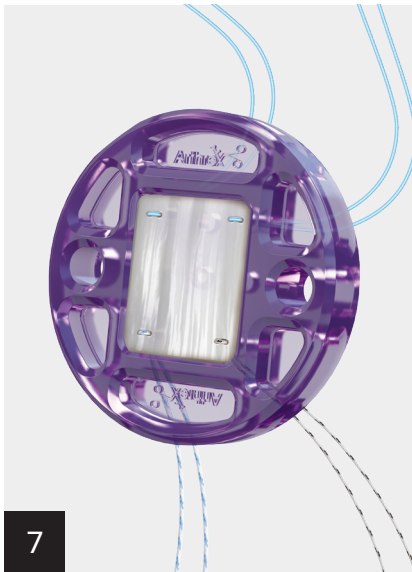

Repeat on the opposite lateral corner with FiberLink™ or TigerLink™ SutureTape. Use the opposite suture color to help with suture management.

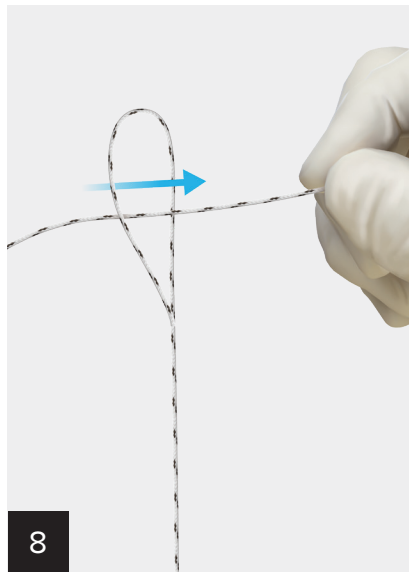

On the lateral side of the graft, pass the tail end of the FiberLink and TigerLink SutureTape through the corresponding looped end to create a cinch stitch configuration.

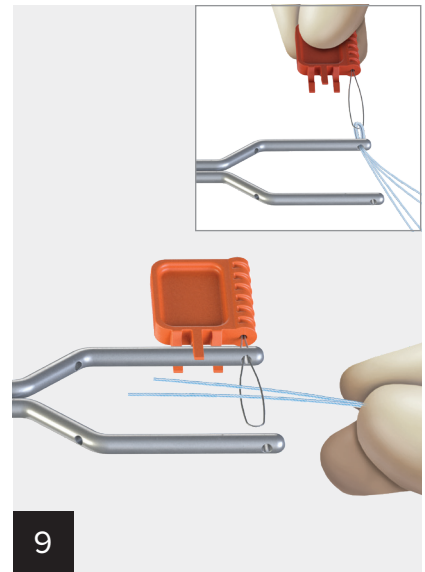

Using the suture-passing flag, pass FiberLoop® sutures from the medial side of the graft through the channels at the distal end of the spreader.

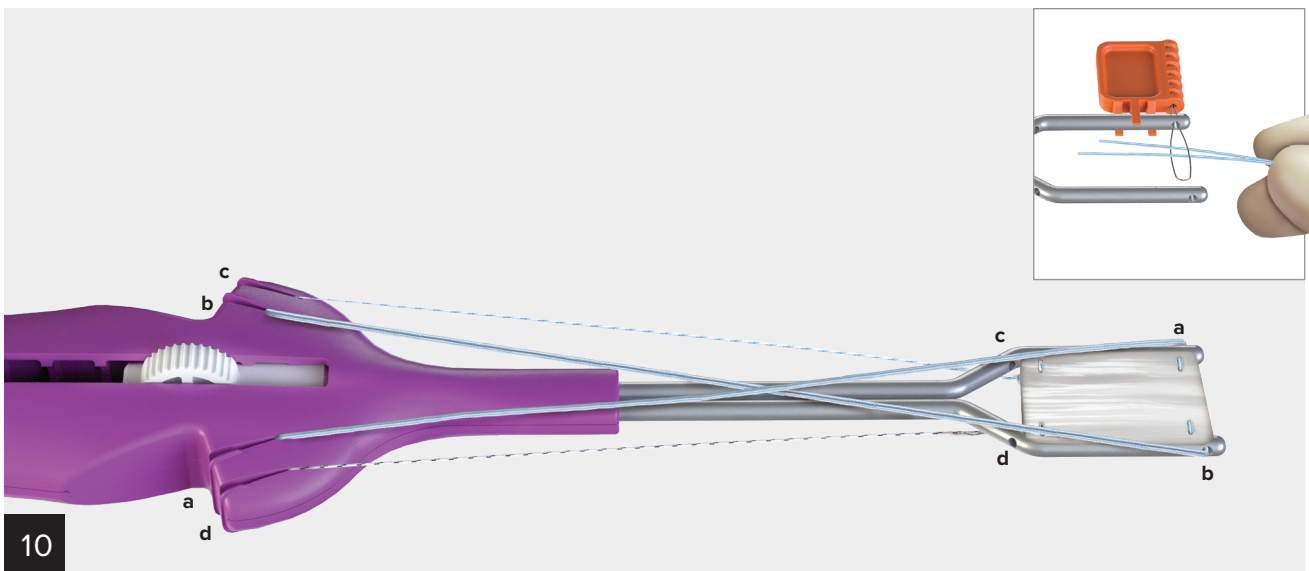

Using the suture passing flag, pass the FiberLoop sutures from the medial aspect of the graft into the suture channels at the distal end of the graft spreader (a, b). Take care to cleat the medial sutures on the inside cleats (a,b), creating a crisscross pattern that eases passage through the 10 mm PassPort Button™ cannula and retains tension on the graft.

Pass the lateral TigerLink™ SutureTape and FiberLink™ SutureTape under the arms of the spreader and attach to the outside cleats (c,d) on the corresponding side of the graft spreader handle.

Note: Do not pass the lateral link sutures through the lateral channels on the graft spreader arms as this will complicate removal after graft insertion.

Ordering Information

CuffMend™ Rotator Cuff Augmentation Implant System

Product Description	Item Number
<ul style="list-style-type: none"> ■ Two FiberStitch™ Implant 1.5, Curved (RC) w/ 2 Polyester Implants and 2-0 FiberWire® Sutures ■ Two 3.5 mm PushLock® Anchors, BioComposite, Self-Punching ■ Graft Spreader ■ Three #0 FiberWire Sutures, 38 in (blue) ■ FiberLink™ SutureTape, 0.9 mm, w/ loop (white/blue) ■ TigerLink™ SutureTape, 0.9 mm, w/ loop (white/black) ■ HD Scorpion™ Needle w/ MegaLoader ■ Knot Pusher/Suture Cutter with w/ Portal Skid 	AR-19041S

Implants

Product Description	Item Number
FiberStitch Implant 1.5, Straight (RC) w/ 2 Polyester Implants and 2-0 FiberWire	AR-19032S
FiberStitch Implant 1.5, Curved (RC) w/ 2 Polyester Implants and 2-0 FiberWire	AR-19032C
3.5 mm PushLock Anchors, BioComposite, Self-Punching	AR-1926BCSP
3.5 mm PushLock Anchors, PEEK, Self-Punching	AR-1926PSSP

ArthroFLEX® Dermal Allograft

Product Description	Item Number
ArthroFlex Dermal Allograft, 20 mm × 25 mm × 1.0 mm, decellularized dermis w/ Matracell technology	AFLEX402
ArthroFlex Dermal Allograft, 25 mm × 30 mm × 1.0 mm, decellularized dermis w/ Matracell technology	AFLEX403
ArthroFlex Dermal Allograft, 25 mm × 30 mm × 2.0 mm, decellularized dermis w/ Matracell technology	AFLEX202
ArthroFlex Dermal Allograft, 20 mm x 30 mm x 3.0 mm, decellularized dermis w/ Matracell technology	AFLEX352

Instrumentation and Graft Preparation

Product Description	Item Number
Knot Pusher/Suture Cutter w/ Portal Skid	AR-5845
Graft Spreader	AR-19007GS
FiberLink SutureTape, 0.9 mm w/ Loop (white/blue)	AR-7559
TigerLink SutureTape, 0.9 mm w/ Loop (white/black)	AR-7559T
#0 FiberWire Suture, 38 in (blue)	AR-7254
FastPass Scorpion SL Suture Passer	AR-13999MF
HD Scorpion Needle	AR-13999HDN
FiberWire Scissor	AR-11796

Autograft Tissue Compression System

Product Description	Item Number
Instrument Set, ATCS	AR-19081S
Compression Plates, ATCS, Single Use	AR-19083
FiberLoop® Suture, 20 in (blue), 76 mm straight needle w/ 7 mm loop	AR-7253

Cannulas and Cannula Accessories

Product Description	Item Number
PassPort Button™ Cannula, 10 mm I.D. x 2 cm	AR-6592-10-20
PassPort Button Cannula, 10 mm I.D. x 3 cm	AR-6592-10-30
PassPort Button Cannula, 10 mm I.D. x 4 cm	AR-6592-10-40
PassPort Button Cannula, 10 mm I.D. x 5 cm	AR-6592-10-50
10 mm PassPort Button Inserter	AR-6592-10PI

References

1. Hartzler RU, Softic D, Qin X, Dorfman A, Adams CR, Burkhart SS. The histology of a healed superior capsular reconstruction dermal allograft: a case report. *Arthroscopy*. 2019;35(10):2950-2958. doi:10.1016/j.arthro.2019.06.024
2. Ely EE, Figueroa NM, Gilot GJ. Biomechanical analysis of rotator cuff repairs with extracellular matrix graft augmentation. *Orthopedics*. 2014;37(9):608-614. doi:10.3928/01477447-20140825-05
3. Gilot GJ, Alvarez-Pinzon AM, Barcksdale L, Westerdahl D, Krill M, Peck E. Outcome of large to massive rotator cuff tears repaired with and without extracellular matrix augmentation: a prospective, comparative study. *Arthroscopy*. 2015;31(8):1459-1465. doi:10.1016/j.arthro.2015.02.032
4. Denard PJ, Brady PC, Adams CR, Tokish JM, Burkhart SS. Preliminary results of arthroscopic superior capsule reconstruction with dermal allograft. *Arthroscopy*. 2018;34(1):93-99. doi:10.1016/j.arthro.2017.08.265
5. Moore MA, Samsell B, Wallis G, et al. Decellularization of human dermis using non-denaturing anionic detergent and endonuclease: a review. *Cell Tissue Bank*. 2015;16(2):249-259. doi:10.1007/s10561-014-9467-4
6. Arthrex, Inc. Data on file (Biomechanical properties of tendon augmentation material; LA0822-EN, TR-4926). Naples, FL; 2011.
7. LifeNet Health. Sterile decellularized dermis instructions for use [63-0050-01]. Virginia Beach, VA; 2019.
8. LifeNet Health. Analysis of the acellular matrix, growth factors, and cytokines present in ArthroFlex® [68-20-048]. Virginia Beach, VA; 2012.



This description of technique is provided as an educational tool and clinical aid to assist properly licensed medical professionals in the usage of specific Arthrex products. The medical professional must use their professional judgment in making any final determinations in product usage and technique. In doing so, the medical professional should rely on their own training and experience and should conduct a thorough review of pertinent medical literature and the product's Directions for Use. Postoperative management is patient specific and dependent on the treating professional's assessment. Individual results will vary and not all patients will experience the same postoperative activity level or outcomes.



Arthrex manufacturer,
authorized representative,
and importer information
(Arthrex eFUs)



US patent information

The LifeNet Health logo, ArthroFlex,
Matracell, and Preservon are registered
trademarks of LifeNet Health.

arthrex.com